

200mA/500mA Fixed Output Voltage LDO Regulator

General Description

The RT9168/A is a 200mA/500mA low dropout and micropower regulator suitable for portable applications. The output voltages range from 1.5V to 5.0V in 100mV increments and 2% accuracy. The RT9168/A is designed for use with very low ESR capacitors. The output remains stable even with a 1μF ceramic output capacitor.

The RT9168/A uses an internal PMOS as the pass device, which does not cause extra GND current in heavy load and dropout conditions. The shutdown mode of nearly zero operation current makes the IC suitable for battery-powered devices. Other features include current limiting and over temperature protection. The SOT-23-5 and SOP-8 packages are also available for larger power dissipation and design flexibility.

Ordering Information

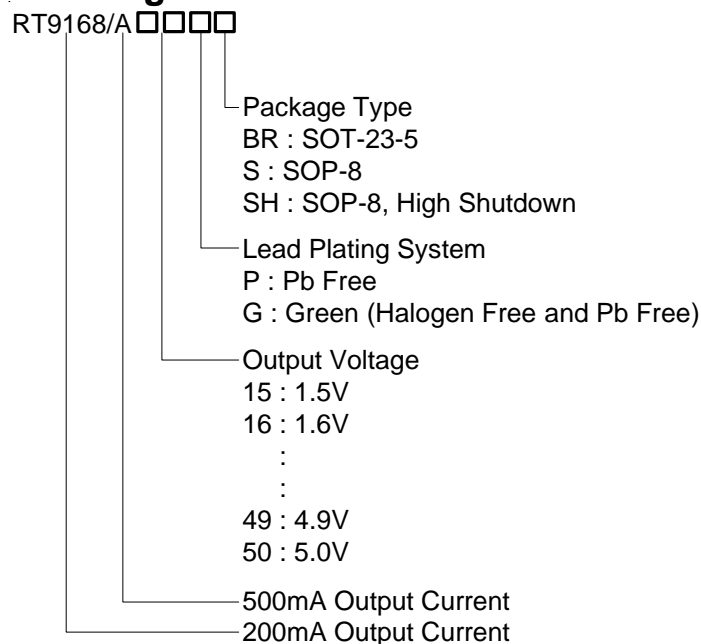

Note :

Richtek products are :

- ▶ RoHS compliant and compatible with the current requirements of IPC/JEDEC J-STD-020.
- ▶ Suitable for use in SnPb or Pb-free soldering processes.

Features

- Stable with Low-ESR Output Capacitor
- Low Dropout Voltage (220mV at 200mA)
- Low Operation Current –80μA Typical
- Shutdown Function
- Low Temperature Coefficient
- Current and Thermal Limiting
- Custom Voltage Available
- SOT-23-5 and SOP-8 Packages
- RoHS Compliant and 100% Lead (Pb)-Free

Applications

- Cellular Telephones
- Laptop, Notebook, and Palmtop Computers
- Battery-powered Equipment
- Hand-held Equipment

Marking Information

For marking information, contact our sales representative directly or through a Richtek distributor located in your area.

Pin Configurations

(TOP VIEW)

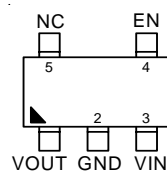

SOT-23-5

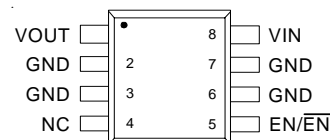

SOP-8

Typical Application Circuit

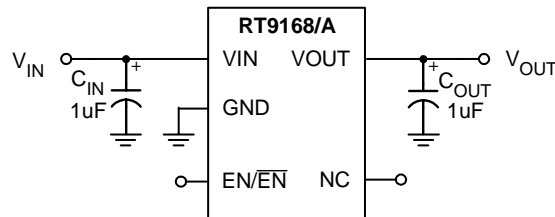

Functional Pin Description

| Pin Name | Pin Function |
|-------------------------------|-------------------------------|
| VIN | Input Voltage |
| GND | Ground |
| EN ($\overline{\text{EN}}$) | Chip Enable Active High (Low) |
| NC | No Connection |
| VOUT | Output Voltage |

Function Block Diagram

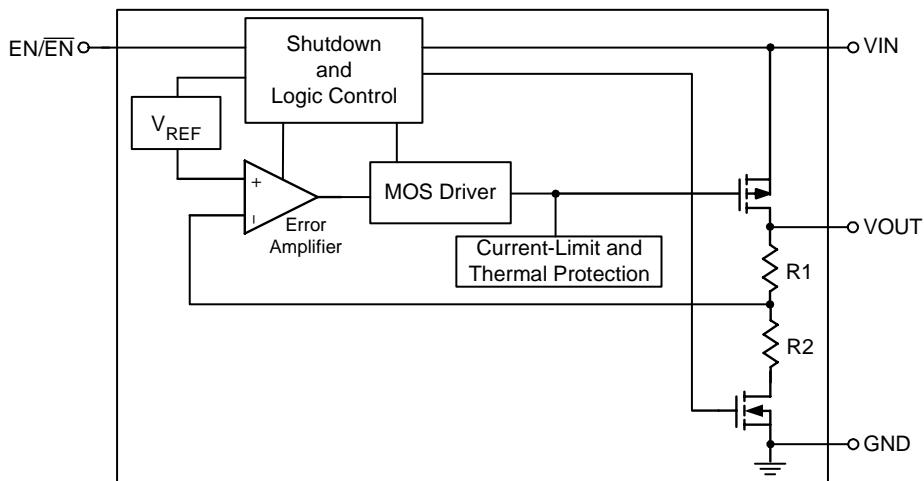

Absolute Maximum Ratings

- Input Voltage ----- 8V
- Power Dissipation, P_D @ $T_A = 25^\circ\text{C}$
 - SOT-23-5 ----- 0.4W
 - SOP-8 ----- 0.625W
- Package Thermal Resistance (Note1)
 - SOT-23-5, θ_{JA} ----- 250°C/W
 - SOP-8, θ_{JA} ----- 160°C/W
- Operating Junction Temperature Range ----- -40°C to 125°C
- Storage Temperature Range ----- -65°C to 150°C
- Lead Temperature (Soldering, 10 sec.) ----- 260°C

Electrical Characteristics

($V_{IN} = 5.0\text{V}$, $C_{IN} = 1\mu\text{F}$, $C_{OUT} = 1\mu\text{F}$, $T_A = 25^\circ\text{C}$, unless otherwise specified)

| Parameter | Symbol | Test Conditions | Min | Typ | Max | Unit | |
|--|-------------------|---|--|------|------|------------------|---------------|
| Input Voltage Range | V_{IN} | | 2.9 | -- | 7 | V | |
| | | $I_L = 50\text{mA}$ | 2.7 | -- | 7 | | |
| Output Voltage Accuracy | ΔV_{OUT} | $I_L = 1\text{mA}$ | -2 | -- | +2 | % | |
| Maximum Output Current | RT9168 | I_{MAX} | 200 | -- | -- | mA | |
| | RT9168A | | 500 | -- | -- | mA | |
| Current Limit | RT9168 | I_{LIM} | $R_{LOAD} = 1\Omega$ | -- | 300 | -- | mA |
| | RT9168A | | | -- | 700 | -- | mA |
| GND Pin Current | RT9168/A | I_G | No Load | -- | 80 | 150 | μA |
| | RT9168 | | $I_{OUT} = 200\text{mA}$ | -- | 90 | 150 | |
| | RT9168A | | $I_{OUT} = 500\text{mA}$ | -- | 90 | 150 | |
| Dropout Voltage ⁽²⁾ ($V_{OUT}(\text{Nominal}) \geq 3.0\text{V}$ Version) | RT9168/A | V_{DROP} | $I_{OUT} = 1\text{mA}$ | -- | 1.1 | 5 | mV |
| | RT9168/A | | $I_{OUT} = 50\text{mA}$ | -- | 55 | 100 | mV |
| | RT9168/A | | $I_{OUT} = 200\text{mA}$ | -- | 220 | 300 | mV |
| | RT9168A | | $I_{OUT} = 500\text{mA}$ | -- | 600 | 750 | mV |
| Line Regulation | ΔV_{LINE} | $V_{IN} = (V_{OUT} + 0.15)$ to 7V , $I_{OUT} = 1\text{mA}$ | -0.2 | -- | +0.2 | %/V | |
| Load Regulation | RT9168/A | ΔV_{LOAD} | $I_{OUT} = 0\text{mA}$ to 200mA | -- | 0.01 | 0.04 | %/mA |
| | RT9168A | | $I_{OUT} = 0\text{mA}$ to 500mA | -- | 0.01 | 0.04 | |
| EN, $\overline{\text{EN}}$ Input High Threshold | V_{IH} | $V_{IN} = 3\text{V}$ to 5.5V | 2.2 | -- | -- | V | |
| EN, $\overline{\text{EN}}$ Input Low Threshold | V_{IL} | $V_{IN} = 3\text{V}$ to 5.5V | -- | -- | 0.4 | V | |
| EN, $\overline{\text{EN}}$ Bias Current | I_{SD} | | -- | -- | 100 | nA | |
| Shutdown Supply Current | I_{GSD} | $V_{OUT} = 0\text{V}$ | -- | 0.01 | 1 | μA | |
| Thermal Shutdown Temperature | T_{SD} | | -- | 155 | -- | $^\circ\text{C}$ | |
| Ripple Rejection | PSRR | $F = 100\text{Hz}$, $C_{BP} = 10\text{nF}$, $C_{OUT} = 10\mu\text{F}$ | -- | 58 | -- | dB | |

Note 1. θ_{JA} is measured in the natural convection at $T_A = 25^\circ\text{C}$ on a low effective thermal conductivity test board of JEDEC 51-3 thermal measurement standard.

Note 2. The dropout voltage is defined as $V_{IN} - V_{OUT}$, which is measured when V_{OUT} is $V_{OUT(NORMAL)} - 100\text{mV}$.

Typical Operating Characteristics

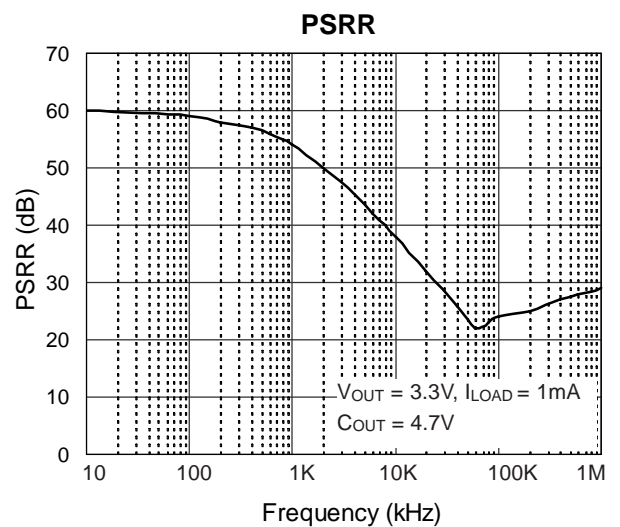
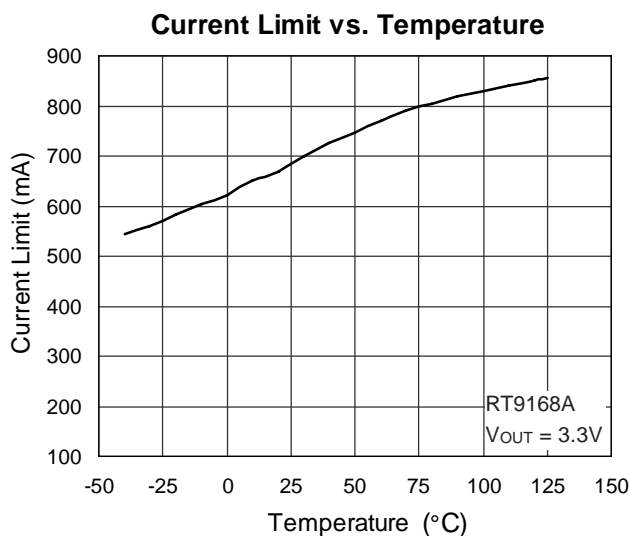
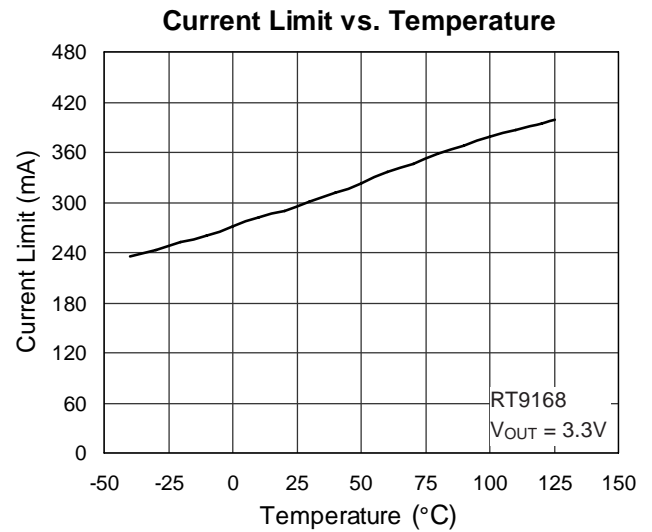
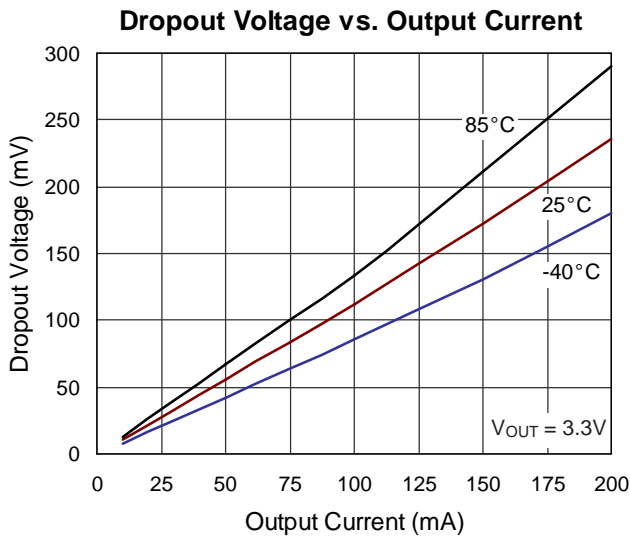
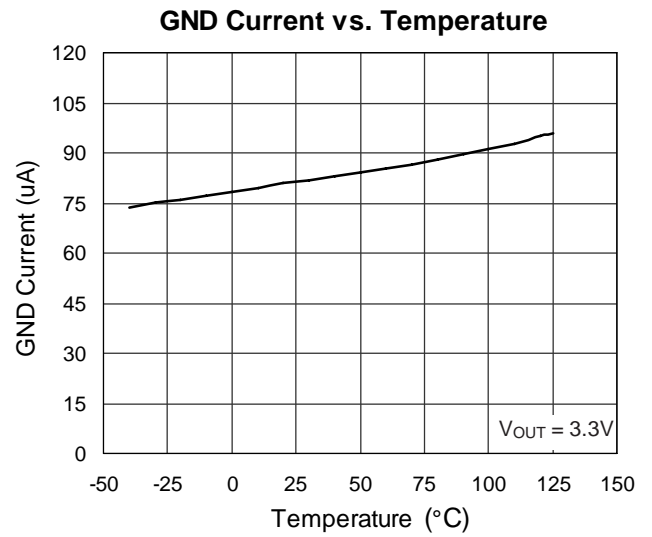
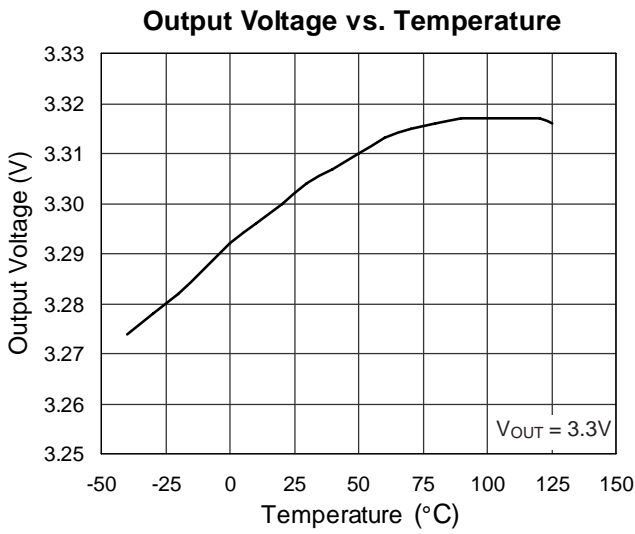

Load Transient Response

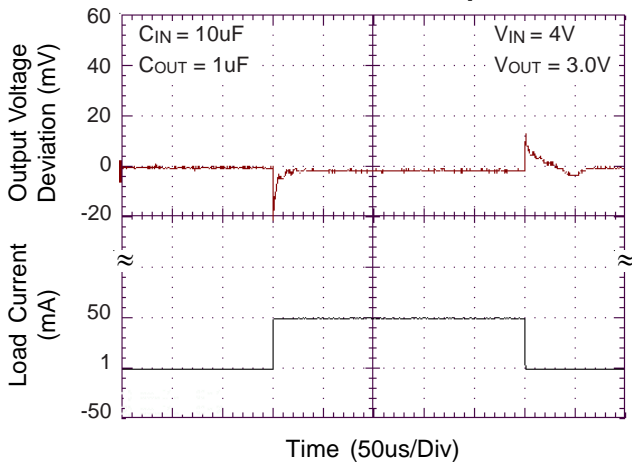

Load Transient Response

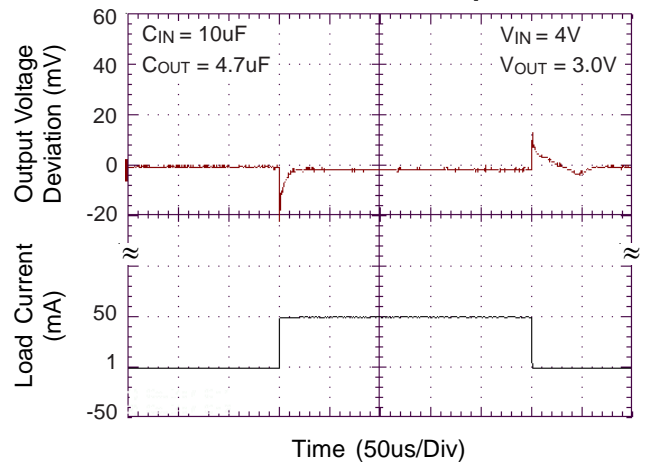

Line Transient Response

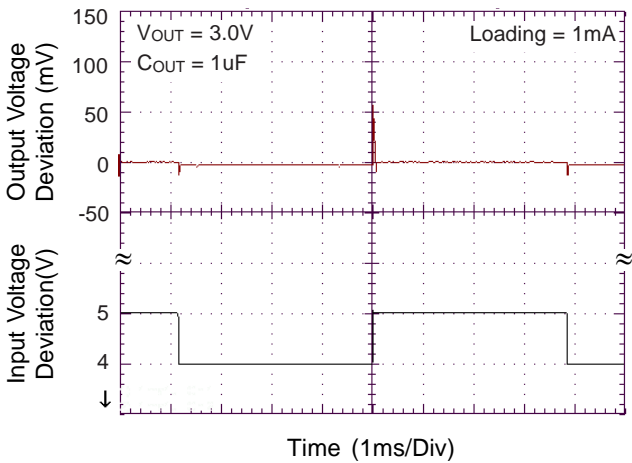

Line Transient Response

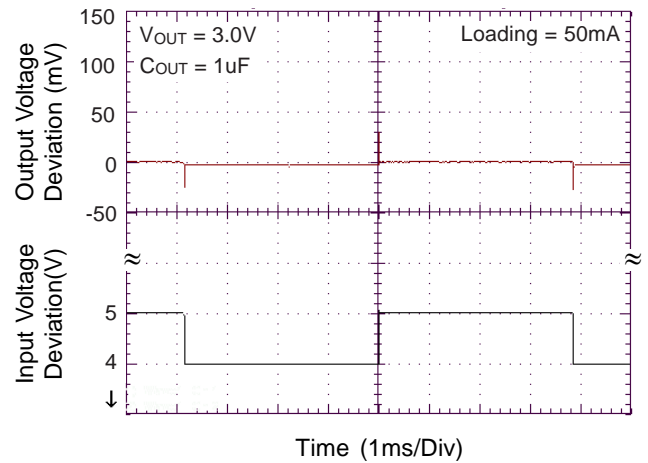

Line Transient Response

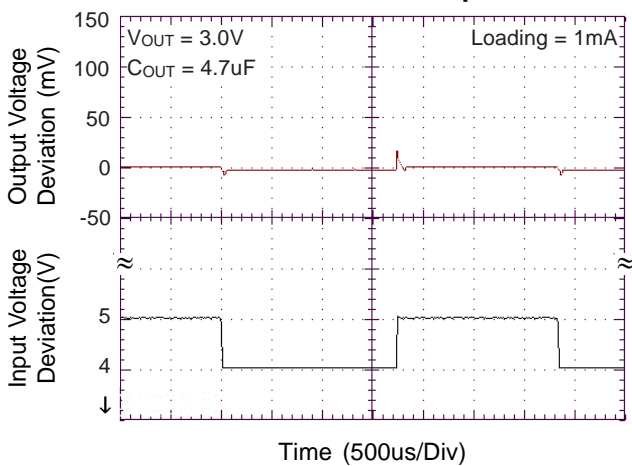

Line Transient Response

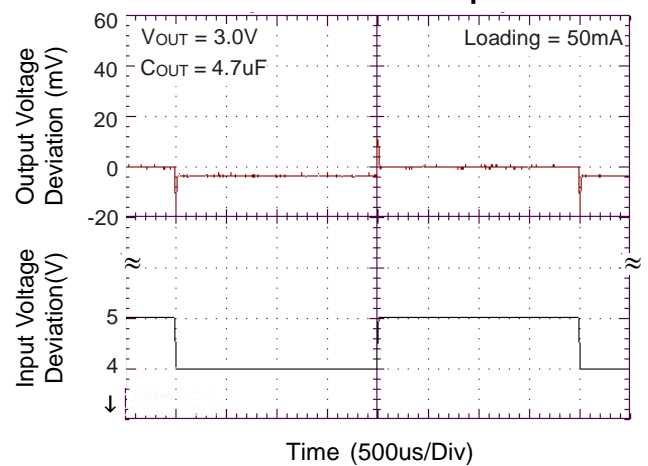

Application Information

Capacitor Selection and Regulator Stability

Like any low-dropout regulator, the external capacitors used with the RT9168/A must be carefully selected for regulator stability and performance.

Using a capacitor whose value is $> 1\mu\text{F}$ on the RT9168/A input and the amount of capacitance can be increased without limit. The input capacitor must be located not more than 0.5" from the input pin of the IC and returned to a clean analog ground. Any good quality ceramic or tantalum can be used for this capacitor. The capacitor with larger value and lower ESR (equivalent series resistance) provides better PSRR and line-transient response.

The output capacitor must meet both requirements for minimum amount of capacitance and ESR in all LDO applications. The RT9168/A is designed specifically to work with low ESR ceramic output capacitor in space-saving and performance consideration. Using a ceramic capacitor whose value is at least $1\mu\text{F}$ with ESR is $> 5\text{m}\Omega$ on the RT9168/A output ensures stability. The RT9168/A still works well with output capacitor of other types due to the wide stable ESR range. Figure 1 shows the curves of allowable ESR range as a function of load current for various output voltages and capacitor values. Output capacitor of larger capacitance can reduce noise and improve load-transient response, stability, and PSRR. The output capacitor should be located not more than 0.5" from the VOUT pin of the RT9168/A and returned to a clean analog ground.

Note that some ceramic dielectrics exhibit large capacitance and ESR variation with temperature. It may be necessary to use $2.2\mu\text{F}$ or more to ensure stability at temperatures below -10°C in this case. Also, tantalum capacitors, $2.2\mu\text{F}$ or more may be needed to maintain capacitance and ESR in the stable region for strict application environment.

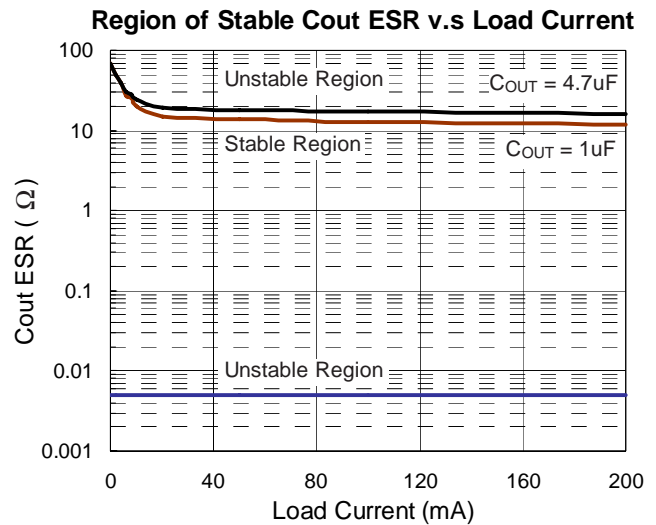

Figure 1

Tantalum capacitors maybe suffer failure due to surge current when it is connected to a low-impedance source of power (like a battery or very large capacitor). If a tantalum capacitor is used at the input, it must be guaranteed to have a surge current rating sufficient for the application by the manufacture.

Load-Transient Considerations

The RT9168/A load-transient response graphs (see Typical Operating Characteristics) show two components of the output response: a DC shift from the output impedance due to the load current change, and the transient response. The DC shift is quite small due to the excellent load regulation of the IC. Typical output voltage transient spike for a step change in the load current from 0mA to 50mA is tens mV, depending on the ESR of the output capacitor. Increasing the output capacitor's value and decreasing the ESR attenuates the overshoot.

Shutdown Input Operation

The RT9168/A is shutdown by pulling the EN input low, and turned on by driving the input high. If this feature is not to be used, the EN input should be tied to VIN to keep the regulator on at all times (the EN input must **not** be left floating).

To ensure proper operation, the signal source used to drive the EN input must be able to swing above and below the specified turn-on/turn-off voltage thresholds which guarantee an ON or OFF state (see Electrical Characteristics). The ON/OFF signal may come from either CMOS output, or an open-collector output with pull-up resistor to the RT9168/A input voltage or another logic supply. The high-level voltage may exceed the RT9168/A input voltage, but must remain within the absolute maximum ratings for the EN pin.

Internal P-Channel Pass Transistor

The RT9168/A features a typical 1.1Ω P-Channel MOSFET pass transistor. It provides several advantages over similar designs using PNP pass transistors, including longer battery life. The P-channel MOSFET requires no base drive, which reduces quiescent current considerably. PNP-based regulators waste considerable current in dropout when the pass transistor saturates. They also use high base-drive currents under large loads. The RT9168/A does not suffer from these problems and consume only 80μA of quiescent current whether in dropout, light-load, or heavy-load applications.

Input-Output (Dropout) Voltage

A regulator's minimum input-output voltage differential (or dropout voltage) determines the lowest usable supply voltage. In battery-powered systems, this will determine the useful end-of-life battery voltage. Because the RT9168/A uses a P-channel MOSFET pass transistor, the dropout voltage is a function of drain-to-source on-resistance [$R_{DS(ON)}$] multiplied by the load current.

Reverse Current Path

The power transistor used in the RT9168/A has an inherent diode connected between the regulator input and output (see Figure 2). If the output is forced above the input by more than a diode-drop, this diode will become forward biased and current will flow from the V_{OUT} terminal to V_{IN} . This diode will also be turned on by abruptly stepping the input voltage to a value below the output voltage. To prevent regulator mis-operation, a Schottky diode should be used in any applications where input/output voltage conditions can cause the internal diode to be turned on (see Figure

3). As shown, the Schottky diode is connected in parallel with the internal parasitic diode and prevents it from being turned on by limiting the voltage drop across it to about 0.3V. < 100 mA to prevent damage to the part.

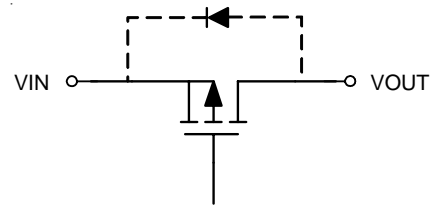

Figure 2

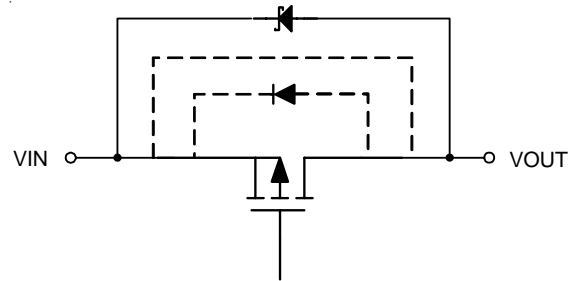

Figure 3

Current Limit and Thermal Protection

The RT9168 includes a current limit which monitors and controls the pass transistor's gate voltage limiting the output current to 300mA Typ. (700mA Typ. for RT9168A). Thermal-overload protection limits total power dissipation in the RT9168/A. When the junction temperature exceeds $T_J = +155^{\circ}\text{C}$, the thermal sensor signals the shutdown logic turning off the pass transistor and allowing the IC to cool. The thermal sensor will turn the pass transistor on again after the IC's junction temperature cools by 10°C , resulting in a pulsed output during continuous thermal-overload conditions. Thermal-overloaded protection is designed to protect the RT9168/A in the event of fault conditions. Do not exceed the absolute maximum junction-temperature rating of $T_J = +150^{\circ}\text{C}$ for continuous operation. The output can be shorted to ground for an indefinite amount of time without damaging the part by cooperation of current limit and thermal protection.

Operating Region and Power Dissipation

The maximum power dissipation of RT9168/A depends on the thermal resistance of the case and circuit board, the temperature difference between the die junction and ambient air, and the rate of airflow. The power dissipation across the device is $P = I_{OUT} (V_{IN} - V_{OUT})$. The maximum power dissipation is: $P_{MAX} = (T_J - T_A) / \theta_{JA}$

where $T_J - T_A$ is the temperature difference between the RT9168/A die junction and the surrounding environment, θ_{JA} is the thermal resistance from the junction to the surrounding environment. The GND pin of the RT9168/A performs the dual function of providing an electrical connection to ground and channeling heat away. Connect the GND pin to ground using a large pad or ground plane.

Outline Dimension

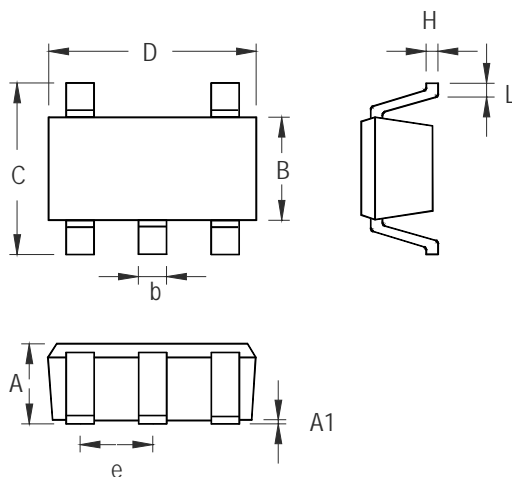

| Symbol | Dimensions In Millimeters | | Dimensions In Inches | |
|--------|---------------------------|-------|----------------------|-------|
| | Min | Max | Min | Max |
| A | 0.889 | 1.295 | 0.035 | 0.051 |
| A1 | 0.000 | 0.152 | 0.000 | 0.006 |
| B | 1.397 | 1.803 | 0.055 | 0.071 |
| b | 0.356 | 0.559 | 0.014 | 0.022 |
| C | 2.591 | 2.997 | 0.102 | 0.118 |
| D | 2.692 | 3.099 | 0.106 | 0.122 |
| e | 0.838 | 1.041 | 0.033 | 0.041 |
| H | 0.080 | 0.254 | 0.003 | 0.010 |
| L | 0.300 | 0.610 | 0.012 | 0.024 |

SOT-23-5 Surface Mount Package

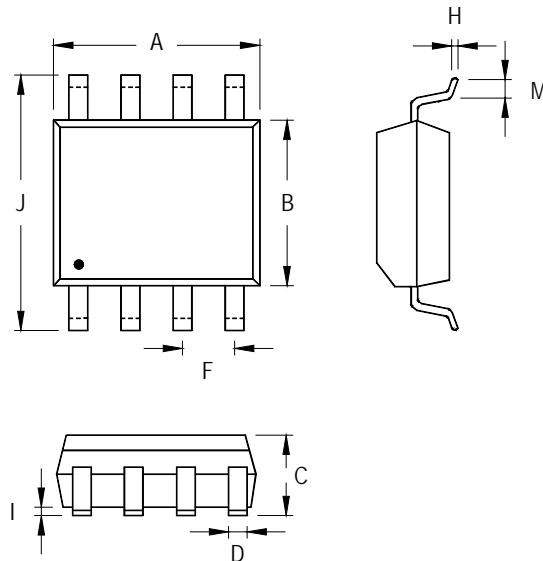

| Symbol | Dimensions In Millimeters | | Dimensions In Inches | |
|--------|---------------------------|-------|----------------------|-------|
| | Min | Max | Min | Max |
| A | 4.801 | 5.004 | 0.189 | 0.197 |
| B | 3.810 | 3.988 | 0.150 | 0.157 |
| C | 1.346 | 1.753 | 0.053 | 0.069 |
| D | 0.330 | 0.508 | 0.013 | 0.020 |
| F | 1.194 | 1.346 | 0.047 | 0.053 |
| H | 0.170 | 0.254 | 0.007 | 0.010 |
| I | 0.050 | 0.254 | 0.002 | 0.010 |
| J | 5.791 | 6.200 | 0.228 | 0.244 |
| M | 0.400 | 1.270 | 0.016 | 0.050 |

8-Lead SOP Plastic Package

Richtek Technology Corporation

Headquarter
 5F, No. 20, Taiyuen Street, Chupei City
 Hsinchu, Taiwan, R.O.C.
 Tel: (8863)5526789 Fax: (8863)5526611

Richtek Technology Corporation

Taipei Office (Marketing)
 5F, No. 95, Minchiuan Road, Hsintien City
 Taipei County, Taiwan, R.O.C.
 Tel: (8862)86672399 Fax: (8862)86672377
 Email: marketing@richtek.com

Information that is provided by Richtek Technology Corporation is believed to be accurate and reliable. Richtek reserves the right to make any change in circuit design, specification or other related things if necessary without notice at any time. No third party intellectual property infringement of the applications should be guaranteed by users when integrating Richtek products into any application. No legal responsibility for any said applications is assumed by Richtek.