

BEING
Medical Equipment



佛山市碧盈醫療器材有限公司

BEING FOSHAN MEDICAL EQUIPMENT Co.,Ltd.

地址:广东省佛山市南海区狮山镇北园东路9号

电话:0757-86406507, 86406509

传真:0757-86406509

网址:www.beingfoshan.com

邮箱:beingfoshan@beingfoshan.com

Add.: No.9, North Park East Road, Shishan Town,

Nanhai District,528225 Foshan,Guangdong, China

Tel.:+86-757-86406505,86406506

Fax:+86-757-86406506

Web.:www.beingfoshan.com

Email:beingfoshan@beingfoshan.com

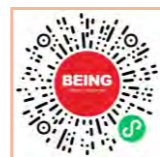

国内官网小程序



碧盈官网PC端



碧盈服务号

得心应手 轻松自如

HANDY AND EASY

Since 2005

佛山市碧盈醫療器材有限公司

BEING FOSHAN MEDICAL EQUIPMENT Co.,Ltd.

真善美

True Kind Beautiful



BEING

Medical Equipment

企业简介 Introduction

科技 速度 创新 突破

TECHNOLOGY SPEED INNOVATION BREAKTHROUGH

佛山市碧盈医疗器材有限公司是一家专业生产高精度牙科器材的高新技术企业。公司成立于2005年，坐落于佛山市南海经济开发区，办公和生产面积达20,000平方米。

凭借精湛的技术，公司成功开发和生产了具有国际水准的高品质牙科手机及相关牙科系列产品，包括各种牙科高速和低速手机、内置式和外置式牙科微型电机、多功能牙科治疗机、牙科光固化机、口腔观察仪等。

2006年，公司获得了ISO13485:2016质量管理体系认证，以及德国TUV SUD的CE证书。2007年，被评为中国AAA级重质量、守信用企业。2014年，被国家科技部认定为“高新技术企业”。2022年和2024年，又分别荣获广东省工业和信息化厅的“创新型中小企业”和“专精特新企业”称号。

展望未来，公司将继续开拓创新，为广大用户研发更多性能卓越、高性价比的产品，提供更广泛的选择，以满足口腔医疗领域的更高要求。碧盈产品将持续助力医者，为全球口腔医疗事业的发展贡献力量。

Being Foshan Medical Equipment Co., Ltd. is a high-tech enterprise specializing in the production of high-precision dental medical equipment. Founded in August 2005, we are located in Nanhai Economic Development Zone, Foshan City, with over 20,000 square meters of office and production space.

With advanced technology, we have successfully developed and manufactured high-quality dental handpieces and related products that meet international standards. Our product range includes various dental high-speed and low-speed handpieces, built-in and portable electric micro-motors, dental units, LED curing lights, and oral cameras.

June 2006, we obtained ISO13485:2016 QMS certification. Meanwhile, Being Foshan had gained the CE certificate from German TUV SUD. In 2007, we were awarded the honorary certificate of China's AAA-level quality-cared and honored Chinese enterprise. In 2014, our company was recognized as a "high-tech enterprise" by the Ministry of Science and Technology. In 2022 and 2024, we were awarded the titles of "Innovative Small and Medium Enterprises" and "SRDI Enterprises" by the Department of Industry and Information Technology of Guangdong Province, respectively.

In the future, we will continue to innovate and develop high-performance, cost-effective products for users in the oral medical field. We will provide a wider range of choices to meet the increased requirements of oral healthcare. Our products will continue to assist dentists and contribute to the development of the global oral medical industry.



公司荣誉历程

2005年8月至2024年7月 

Company Honor History Since August 2005

- | | |
|--|--|
| <p>2005年 佛山市碧盈医疗器材公司成立</p> <p>2006年 获ISO9001、ISO13485质量管理体系认证</p> <p>2006年 获TUV SUD 机构颁发CE0123证书</p> <p>2007年 荣获中国AAA级重质量、守信用企业荣誉</p> <p>2013年 佛山市口腔器械行业协会会长单位</p> <p>2014年 荣获高新技术企业认定</p> <p>2018年 荣获南海区工程技术研究中心认定</p> | <p>2018年 荣获佛山市工程技术研究中心认定</p> <p>2018年 荣获佛山高新区瞪羚企业认定</p> <p>2019年 荣获佛山市专精特新企业认定</p> <p>2019年 广东股权交易中心挂牌</p> <p>2020年 荣获黑龙江省科学技术奖一等奖</p> <p>2022年 荣获广东省创新型企业认定</p> <p>2024年 荣获广东省专精特新企业认定</p> |
|--|--|

资质证书 Certificate



与世界俱进

Advancing With The World

我们与世界共同发展,以最具前瞻性的设计理念,坚持以人为本的原则,提供优质的牙科产品,为人类带来健康的新生活!

We are developing at the same height as the world, with the most forward-looking design concept, Adhering to the principle of people-oriented, providing high-quality dental products, and bringing a Healthy new life to mankind!

公司一角 | Corner Of The Company



三楼展厅 | Third floor exhibition hall



研发部 | R&D Department

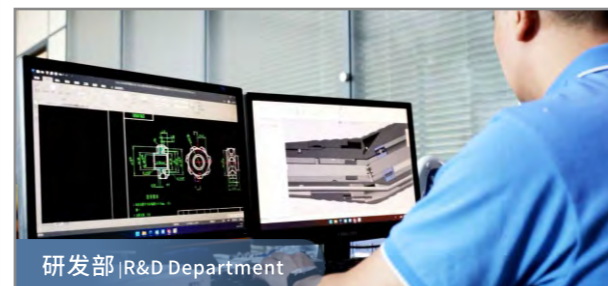

研发部 | R&D Department



机加一车间 | Machinery Workshop One



机加二车间 | Machinery Workshop Two



检测部 | Testing Department

产品目录

Products Contents

高速涡轮牙科手机 Dental High-Speed Air Turbine Handpiece

莲花系列 Lotus Series

- 01-08 快接手机
Quick Coupling Handpiece
- 11-12 迷你头手机
Mini Head Handpiece
- 15-16 大头手机
Torque Head Handpiece
- 09-10 自发光手机
Self-Luminous Handpiece
- 13-14 标准头手机
Standard Head Handpiece

高/低速手机配件 High/Low Speed Handpiece Accessories 17

低速涡轮牙科手机 Low Speed Handpiece

玫瑰系列 Rose Series

- 18-19 Rose 202PB-M4套装
- 21----- Rose 202P-M4套装
- 23----- Rose 201P-M4套装
- 25----- Rose 201-M4套装
- 20----- Rose 202-M4
2CAPB-FG
2CAPB
2SHBW
2SHB
2AMB-M4
- 22----- Rose 202-M4
2CAP-FG
2CAP
2SH
2AM-M4/B2
- 24----- Rose 201-M4
1CAP2
1SH2
1SH-N
1AM-M4/B2
- 26----- Rose 201-M4
1CA-PS
1CAP-FG
1CA
1CAP
1SH
1AM-M4/B2

牙科弯手机 Dental contra angle handpieces

增速弯机 Increasing Contra Angle

- 27----- 迷你头1:5增速弯机
Mini-Head Increasing
- 29----- 钛合金增速弯机
Titanium Increasing Contra Angle
- 28----- 增速弯机
2CA5B
2CA45B
1CA45B
1CA15B
- 30----- 增速弯机
1CA15
Z15B(TC)
Z15B
Z15

20:1种植弯机 Contra Angle: Reduction Implant

牙科弯手机 Dental contra angle handpieces

- 31-32 种植弯机
B201L 1CAR20
B201 1CAR20B-N

牙科弯手机 Dental contra angle handpieces

减速弯机 Contra Angle: Reduction

- 33-34 减速弯机
2CAR4B/2CAR4
2CAR16B/2CAR16
2CAR64B/2CAR64
2CAR128B/2CAR128
- 35-36 可配机头
Head optional
- 37----- 减速弯机
1CAR4
1SHR4
1CAR16
1CAR64

根管弯机头 Endo Motor Contra Angle

38

牙科低压电动马达 Dental Electric Motor

玫瑰系列 Rose Series

- 39----- Portable Type 便携式
- 40----- Built-In Type 内置式

郁金香系列 Tulip Series

牙科光固化机(LED)Dental Curing Light(LED)

- 41----- TULIP 100A (铝Aluminum)
- 42----- TULIP 101A
- 43----- TULIP 200A/200B

口腔数字观察仪 Oral Camera

- 44----- Azalea ST700(A) Azalea St700(C)

技工室无碳刷电动马达 Dental Laboratory Electric Motor

- 45----- PUMA 3000
- 46----- PUMA 4000

图标说明 ICON NAME

- 47----- 图标说明 Icon Name
- 48----- 功能特点的图标 Functional Overview Marking Notes

BEING
Medical Equipment



产品型号 Model	303PBQ-M4	302PQ-M4	302PBQ-M4	302PBQ-M4
货号 Order Number	1M-PBQ-K	2PQ-K	2PBQ1-K-Ti	2PBQ-K(TC)
机身 Body	铜 Copper	铜 Copper	镀钛 Titanium Coating	钛合金 Titanium
机头类型 Head Type	迷你 Mini	大头 Torque Head	大头 Torque Head	大头 Torque Head
机头尺寸(mm) Head Size	φ9×10.7mm	φ12.5×13.02mm	φ12.5×13.02mm	φ12.5×13.02mm
喷雾 Spray	3孔喷水 Triple Spray	3孔喷水 Triple Spray	4孔喷水 Quattro Spray	4孔喷水 Quattro Spray
轴承 Bearing	陶瓷 Ceramics	陶瓷 Ceramics	陶瓷 Ceramics	陶瓷 Ceramics
噪音 Noise	≤60dB	≤60dB	≤60dB	≤60dB
转速 Speed	≥30,000rpm	≥30,000rpm	≥30,000rpm	≥30,000rpm
光纤 Fiber Optic	●	○	●	●
LED	●	○	●	●
按压式换针 Push Button Bur Change	●	●	●	●
锁针式换针 Screw Type Bur Change	○	○	○	○
连接方式 Connection	4孔/6孔 4 Holes/6 Holes	4孔 4 Holes	4孔/6孔 4 Holes/6 Holes	4孔/6孔 4 Holes/6 Holes

可与KAVO快接头通用
Compatible With KAVO Coupling

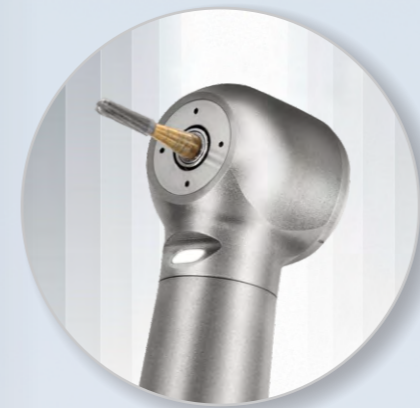

静无止境
Quiet and quiet



四孔喷水/4 Holes Spray
为车针和治疗部位提供360°冷却
Provides 360° cooling for the bur and treatment area.



Ti 高速涡轮牙科手机^(TC)

High-Speed Air Turbine Handpiece

生物兼容性
Biocompatibility

轻巧灵活
Lightweight and Flexible



JX-K8000-00



106KE



106KB

可选快接/Quick Coupling Option

光纤/Fiber Optic

技术参数/Parameter

型号 : Lotus 302PBQ-M4 Model	机头尺寸 : $\phi 12.5 \times 13.02\text{mm}$ Head size	噪音 : $\leq 60\text{dB}$ Noise
货号 : 2PBQ-K(TC) Order Number	转速 : $\geq 30,000\text{rpm}$ Speed	
产品描述 · 陶瓷轴承 · 按压换针式 · 四点喷水 · 防污设计 · 钛合金机身 · 钛合金机头 · 钛合金插座 Description · Ceramic Bearings · Push Button · Quattro Spray · Anti-Fouling Design · Titanium Alloy Body · Titanium Alloy Head · Titanium Alloy Adapter		
功能概述 Functional Overview		

Lotus Series

高速涡轮牙科手机

光纤手机

Fiber Optic Handpiece

高硬度 耐腐蚀 防刮痕
High Hardness, Preservative, Scratch-Resistant



可调水 / Adjustable Water Supply



106KB

卡瓦通用 / KAVO Compatible

6孔 / 6 Holes



钛色 磨砂机身 可选快接

可与KAVO快接头通用 / Compatible with KAVO Coupling

型号: Lotus 302PBQ-M4
机头尺寸: $\phi 12.5 \times 13.02\text{mm}$
噪音: $\leq 60\text{dB}$
产品描述: 陶瓷轴承 · 按压换针式 · 四点喷水
陶瓷轴承 · 按压换针式 · 四点喷水
Ceramic Bearings · Push Button · Quattro Spray

货号: 2PBQ1-K-Ti
转速: $\geq 30,000\text{rpm}$

防污设计 · 镀钛手机
Anti-Fouling Design · Titanium Coating

功能概述 / Functional Overview



光纤 / Fiber Optic



磨砂机身 可选快接

可与KAVO快接头通用 / Compatible with KAVO Coupling

型号: Lotus 302PBQ-M4
机头尺寸: $\phi 12.5 \times 13.02\text{mm}$
噪音: $\leq 60\text{dB}$
产品描述: 陶瓷轴承 · 按压换针式 · 三点喷水
陶瓷轴承 · 按压换针式 · 三点喷水
Ceramic Bearings · Push Button · Triple Spray

货号: 2PBQ2-K
转速: $\geq 30,000\text{rpm}$

防污设计
Anti-Fouling Design

功能概述 / Functional Overview



光纤 / Fiber Optic



磨砂机身 可选快接

可与SIRONA快接头通用 / Compatible with SIRONA Coupling

型号: Lotus 302PBQ-M4
机头尺寸: $\phi 12.5 \times 13.02\text{mm}$
噪音: $\leq 60\text{dB}$
产品描述: 陶瓷轴承 · 按压换针式 · 三点喷水
陶瓷轴承 · 按压换针式 · 三点喷水
Ceramic Bearings · Push Button · Triple Spray

货号: 2PBQ-S
转速: $\geq 30,000\text{rpm}$

防污设计
Anti-Fouling Design

功能概述 / Functional Overview



光纤 / Fiber Optic



磨砂机身 可选快接

可与KAVO快接头通用 / Compatible with KAVO Coupling

型号: Lotus 303PBQ-M4
机头尺寸: $\phi 10.8 \times 13.1\text{mm}$
噪音: $\leq 60\text{dB}$
产品描述: 陶瓷轴承 · 按压换针式 · 三点喷水
陶瓷轴承 · 按压换针式 · 三点喷水
Ceramic Bearings · Push Button · Triple Spray

货号: 3PBQ-K
转速: $\geq 30,000\text{rpm}$

防污设计
Anti-Fouling Design

功能概述 / Functional Overview



光纤 / Fiber Optic



磨砂机身 可选快接

可与KAVO快接头通用/Compatible with KAVO Coupling

型号 : Lotus 302PQ-M4 机头尺寸: $\phi 10.8 \times 12.1\text{mm}$ 噪音 : $\leq 60\text{dB}$ 产品描述 · 陶瓷轴承 · 按压换针式 · 三点喷水
Model Head size Noise Description Ceramic Bearings Push Button Triple Spray

货号 : 3PQ-K 转速 : $\geq 30,000\text{rpm}$ · 防污设计
Order number Speed Anti-Fouling Design

功能概述/Functional Overview



磨砂机身 可选快接

可与SIRONA快接头通用/Compatible with SIRONA Coupling

型号 : Lotus 302PQ-M4 机头尺寸: $\phi 12.5 \times 13.02\text{mm}$ 噪音 : $\leq 60\text{dB}$ 产品描述 · 陶瓷轴承 · 按压换针式 · 三点喷水
Model Head size Noise Description Ceramic Bearings Push Button Triple Spray

货号 : 2PQ-S 转速 : $\geq 30,000\text{rpm}$ · 防污设计
Order number Speed Anti-Fouling Design

功能概述/Functional Overview



磨砂机身 可选快接

可与KAVO快接头通用/Compatible with KAVO Coupling

型号 : Lotus 302PQ-M4 机头尺寸: $\phi 12.5 \times 13.02\text{mm}$ 噪音 : $\leq 60\text{dB}$ 产品描述 · 陶瓷轴承 · 按压换针式 · 三点喷水
Model Head size Noise Description Ceramic Bearings Push Button Triple Spray

货号 : 2PQ-K 转速 : $\geq 30,000\text{rpm}$ · 防污设计
Order number Speed Anti-Fouling Design

功能概述/Functional Overview

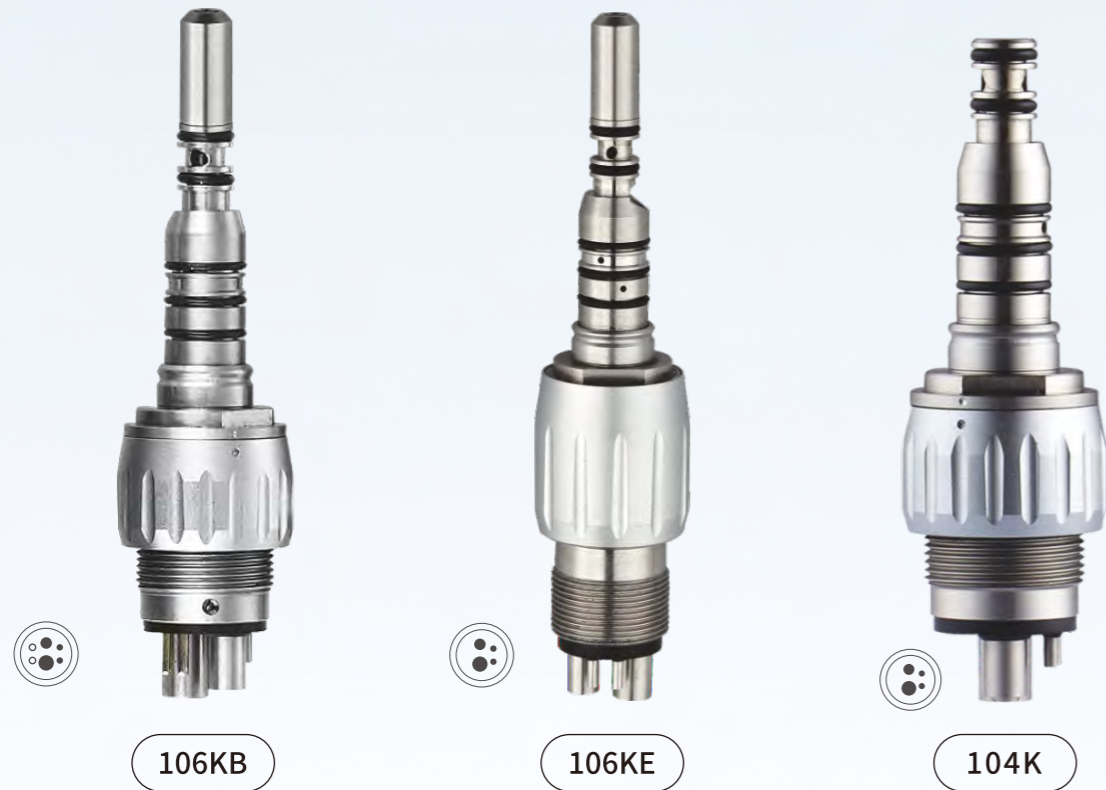

快接 / Quick coupling

型号 Model	106KB	106KE	104K
LED	 LED	 LED	
通用 Compatible	卡瓦通用/KAVO Compatible	卡瓦通用/KAVO Compatible	卡瓦通用/KAVO Compatible
连接方式 Connection	6孔/6 Holes	4孔自发光/4 Holes LED	4孔/4 Holes

快接 / Quick coupling

型号 Model	106SB	104S
LED	 LED	
通用 Compatible	西诺德通用/SIRONA Compatible	西诺德通用/SIRONA Compatible
连接方式 Connection	6孔/6 Holes	4孔/4 Holes

Lotus Series 高速气涡轮手机

自发光手机
Self-Luminous Handpiece



菱型花纹机身

迷你头手机/Mini Head Handpiece

型号 : Lotus 405PE-M4 Model	机头尺寸: $\phi 9 \times 10.7\text{mm}$ Head size	噪音 : $\leq 60\text{dB}$ Noise	产品描述 Description
货号 : 1MP-M4-E Order number	转速 : $\geq 30,000\text{rpm}$ Speed		· 陶瓷轴承 · 按压换针式 · 三点喷水 Ceramic Bearings · Push Button · Triple Spray
			· 防污设计 Anti-Fouling Design

功能概述/Functional Overview



自发光 /LED Self-Luminous



菱型花纹机身

型号 : Lotus 401PE-M4 Model	机头尺寸: $\phi 10.35 \times 14.6\text{mm}$ Head size	噪音 : $\leq 60\text{dB}$ Noise	产品描述 Description
货号 : 1PX1-M4-E Order number	转速 : $\geq 30,000\text{rpm}$ Speed		· 陶瓷轴承 · 按压换针式 · 三点喷水 Ceramic Bearings · Push Button · Triple Spray
			· 防污设计 Anti-Fouling Design

功能概述/Functional Overview



自发光 /LED Self-Luminous



菱型花纹机身

型号 : Lotus 302PE-M4 Model	机头尺寸: $\phi 10.35 \times 14.6\text{mm}$ Head size	噪音 : $\leq 60\text{dB}$ Noise	产品描述 Description
货号 : 2P-M4-E Order number	转速 : $\geq 30,000\text{rpm}$ Speed		· 陶瓷轴承 · 按压换针式 · 三点喷水 Ceramic Bearings · Push Button · Triple Spray
			· 防污设计 Anti-Fouling Design

功能概述/Functional Overview



自发光 /LED Self-Luminous

Lotus Series 高速涡轮牙科手机

迷你头手机 Mini Head Handpiece

轻松抵达治疗部位
Easily Reach The Treatment Area



三孔喷水且防污
Triple Water Spray With
Anti-Fouling Design



可选快接
Quick Coupling Option

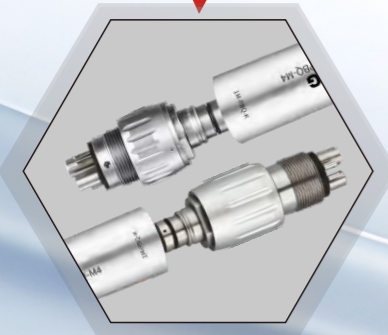

儿童手机：迷你机头 纤细机身

Pediatric Handpiece: Mini Head, Slim Body

迷你机头和纤细机身设计:手术部位视野更广阔、手术操作更灵活。**BEING**碧盈

迷你系列产品尤为适合微创手术,如儿童牙科等。但更普遍来说,

这适合于所有需要小型口腔手术的患者。

Mini head and slim body design: Wider field of view of the surgical site and more flexible surgical operations **BEING**

The Mini Series is particularly suitable for minimally invasive procedures, such as pediatric dentistry. But more generally, this is suitable for all patients who need minor oral surgery

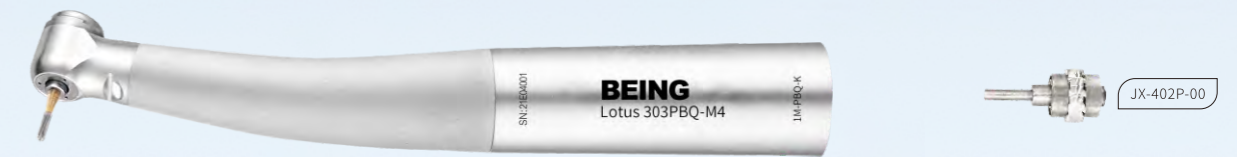

磨砂机身 可选快接

可与KAVO快接头通用/Compatible with KAVO Coupling

型号 : Lotus 303PBQ-M4 Model	机头尺寸: $\phi 9 \times 10.7\text{mm}$ Head size	噪音 : $\leq 60\text{dB}$ Noise	产品描述 Description
货号 : 1M-PBQ-K Order number	转速 : $\geq 30,000\text{rpm}$ Speed		陶瓷轴承 · 按压换针式 · 三点喷水 Ceramic Bearings · Push Button · Triple Spray

功能概述/Functional Overview



光纤/Fiber Optic



光型机身

型号 : Lotus 402-M4 Model	机头尺寸: $\phi 9 \times 10.7\text{mm}$ Head size	噪音 : $\leq 60\text{dB}$ Noise	产品描述 Description
货号 : 1MP-M4 Order number	转速 : $\geq 30,000\text{rpm}$ Speed		陶瓷轴承 · 按压换针式 · 三点喷水 Ceramic Bearings · Push Button · Triple Spray

功能概述/Functional Overview

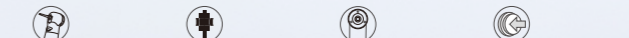

菱形花纹机身

型号 : Lotus 402-M4 Model	机头尺寸: $\phi 10.2 \times 10.4\text{mm}$ Head size	噪音 : $\leq 60\text{dB}$ Noise	产品描述 Description
货号 : 1M-M4 Order number	转速 : $\geq 30,000\text{rpm}$ Speed		陶瓷轴承 · 锁针换针式 · 单点喷水 Ceramic Bearings · Screw Type · Single Spray

功能概述/Functional Overview



Lotus Series

高速涡轮牙科手机

标准头手机

Standard Head Handpiece



不锈钢
Stainless Steel



陶瓷轴承,单点喷水
Ceramic Bearings, Single Water Spray

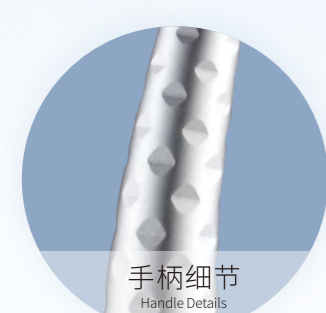

菱形花纹手柄设计,
Diamond Pattern Handle Design
防滑防摔, 清洁方便。
Anti-Slip And Anti-Fall, Easy To Clean.



有两孔和四孔, 可供不同需求的客户选择,
Borden 2 holes or midwest 4 holes connection for option

倒角做工精密、外观整洁美观。
The Chamfering Is Precise And The Appearance Is Neat And Beautiful.

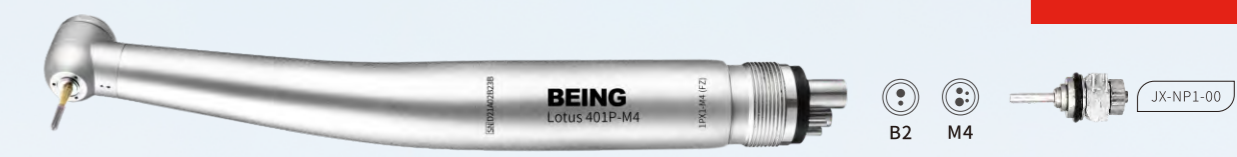

光型机身 不锈钢材质

型号 : Lotus 401P-M4
Model
机头尺寸: $\phi 11.2 \times 14.6\text{mm}$
Head size
噪音 : $\leq 60\text{dB}$
Noise
产品描述 : 陶瓷轴承 · 按压换针式 · 单点喷水
Description : Ceramic Bearings Push Button Single Spray
货号 : 1PX1-M4(FZ)
Order number
转速 : $\geq 30,000\text{rpm}$
Speed
· 防污设计
Anti-Fouling Design

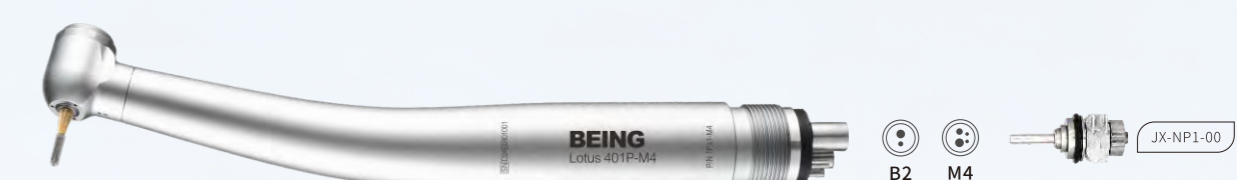
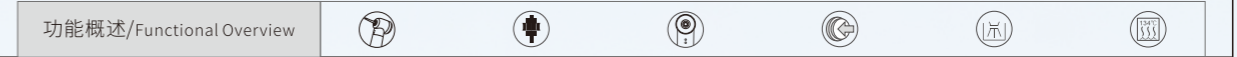

光型机身

型号 : Lotus 401P-M4
Model
机头尺寸: $\phi 11.2 \times 14.6\text{mm}$
Head size
噪音 : $\leq 60\text{dB}$
Noise
产品描述 : 陶瓷轴承 · 按压换针式 · 单点喷水
Description : Ceramic Bearings Push Button Single Spray
货号 : 1PX1-M4
Order number
转速 : $\geq 30,000\text{rpm}$
Speed
· 防污设计
Anti-Fouling Design

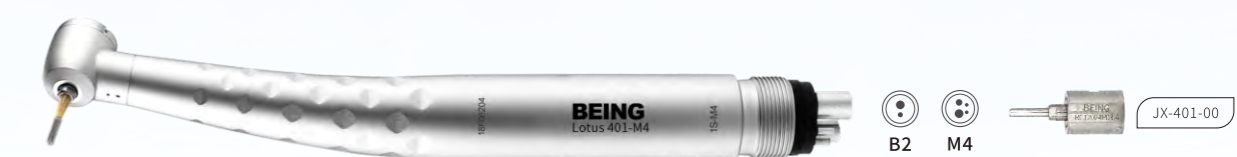

菱形花纹机身

型号 : Lotus 401-M4
Model
机头尺寸: $\phi 11.2 \times 13.14\text{mm}$
Head size
噪音 : $\leq 60\text{dB}$
Noise
产品描述 : 陶瓷轴承 · 锁针换针式 · 单点喷水
Description : Ceramic Bearings Screw Type Single Spray
货号 : 1S-M4
Order number
转速 : $\geq 30,000\text{rpm}$
Speed



菱形花纹机身

型号 : Lotus 401P-M4
Model
机头尺寸: $\phi 11.2 \times 14.6\text{mm}$
Head size
噪音 : $\leq 60\text{dB}$
Noise
产品描述 : 陶瓷轴承 · 按压换针式 · 单点喷水
Description : Ceramic Bearings Push Button Single Spray
货号 : 1PX1-M4 TiL
Order number
转速 : $\geq 30,000\text{rpm}$
Speed
· 防污设计
Anti-Fouling Design

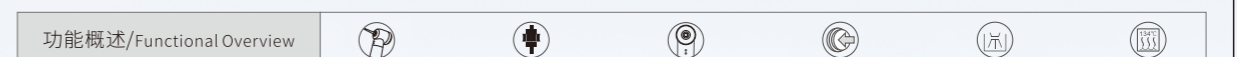

Lotus Series

高速涡轮牙科手机

大头手机

Torque Head Handpiece

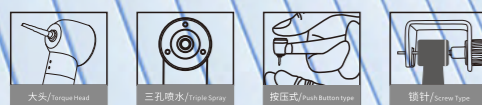

光型机身

型号 : Lotus 302P-M4 机头尺寸: $\phi 12.5 \times 13.2\text{mm}$ 噪音 : $\leq 60\text{dB}$ 产品描述 · 陶瓷轴承 · 按压换针式 · 三点喷水
Model Head size Noise Description Ceramic Bearings Push Button Triple Spray

货号 : 2P-M4 转速 : $\geq 30,000\text{rpm}$
Order number Speed



功能概述/Functional Overview



磨砂机身

型号 : Lotus 302P-M4 机头尺寸: $\phi 12.5 \times 13.2\text{mm}$ 噪音 : $\leq 60\text{dB}$ 产品描述 · 陶瓷轴承 · 按压换针式 · 四点喷水
Model Head size Noise Description Ceramic Bearings Push Button Quattro Spray

货号 : 2P-M4 C 转速 : $\geq 30,000\text{rpm}$ 防污设计
Order number Speed Anti-Fouling Design

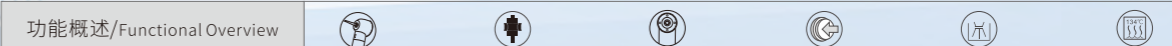

功能概述/Functional Overview



菱形花纹机身

型号 : Lotus 403-M4 机头尺寸: $\phi 12.9 \times 12.2\text{mm}$ 噪音 : $\leq 60\text{dB}$ 产品描述 · 陶瓷轴承 · 锁针换针式 · 单点喷水
Model Head size Noise Description Ceramic Bearings Screw type Single Spray

货号 : 1T-M4 转速 : $\geq 30,000\text{rpm}$
Order number Speed



功能概述/Functional Overview

高/低速手机配件

High/Low Speed Handpiece Accessories

高速手机配件 High-speed Handpiece Accessories

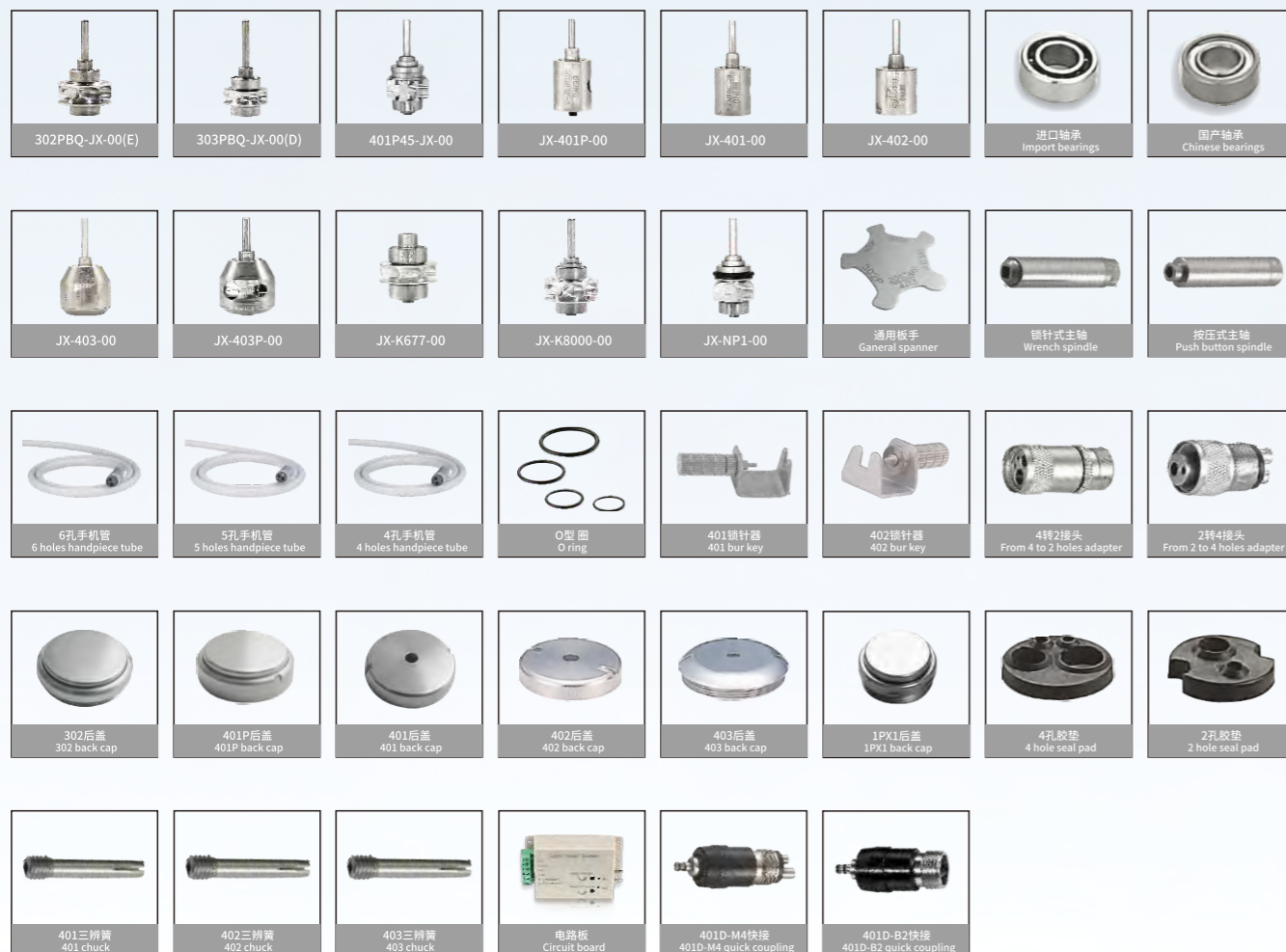

低速手机配件 Low-Speed Handpiece Accessories



低速涡轮牙科手机

Low Speed Handpiece



Rose Series

低速涡轮牙科手机

Low Speed Kit

- 产品描述: E型气动涡轮低速手机套装, 传动比率1:1, 内水道冷却系统
- 气 压: 245~392Kpa(2.5~4.0 kgf/cm²)
- 转 速: 22,000~27,000rpm
- 适用车针: ϕ 2.334~2.35mm
- 水 压: 200Kpa(2.0 bar)
- 噪 音: \leq 65dB
- Description: E type air turbine low speed handpiece kits
Ratio1:1.Internal water spray system
- Air Pressure: 245~392Kpa(2.5~4.0 kgf/cm²)
- Rotation: 22,000~27,000rpm
- Bur Applicable: ϕ 2.334~2.35mm
- Water Pressure: 200Kpa(2.0 bar)
- Noise: \leq 65dB



Rose 202PB-M4套装



Fiber Optic



2CAPB-FG头/Head 2CAPB头/Head

2CAPB-FG
2CAPB

BEING
Medical Equipment



产品型号 Model	Rose 202-M4	Rose 202-M4	Rose 202-M4	Rose 202-M4	Rose 202-M4
货号 Order Number	2CAPB-FG	2CAPB	2SHBW	2SHB	2AMB-M4
机身 Body	铜 Copper	铜 Copper	铜 Copper	铜 Copper	铜 Copper
机型 Handpiece Type	低速弯机 Low Speed Contra Angle	低速弯机 Low Speed Contra Angle	低速直机 Straight Handpiece	低速直机 Straight Handpiece	低速马达 Low Speed Air Momtor
冷却系统 Cooling System	内水道 Internal Water Spray	内水道 Internal Water Spray	内外水道 Internal And External Water Spray	内水道 Internal Water Spray	内水道 Internal Water Spray
齿轮传动比 Gear Ratio	1:1	1:1	1:1	1:1	1:1
噪音 Noise	\leq 50dB	\leq 50dB	\leq 44dB	\leq 60dB	\leq 65dB
转速 Speed	22,000~27,000rpm	22,000~27,000rpm	22,000~27,000rpm	22,000~27,000rpm	22,000~27,000rpm
光纤 Fiber Optic	●	●	●	●	●
按压式换针 Push Button Bur Change	●	●	○	○	○
夹针式换针 Screw Type Bur Change	○	○	●	●	○
连接方式 Connection	E型接口 E Type	E型接口 E Type	E型接口 E Type	E型接口 E Type	6孔 6 Holes

Rose Series

低速涡轮牙科手机

Low Speed Kit

- 产品描述: E型气动涡轮低速手机套装, 传动比率1:1, 内水道冷却系统
- 气 压: 245~392Kpa(2.5~4.0 kgf/cm²)
- 转 速: 22,000~27,000rpm
- 适用车针: ϕ 2.334~2.35mm
- 水 压: 200Kpa(2.0 bar)
- 噪 音: \leq 65dB
- Description: E type air turbine low speed handpiece kits
Ratio 1:1. Internal water spray system
- Air Pressure: 245~392Kpa(2.5~4.0 kgf/cm²)
- Rotation: 22,000~27,000rpm
- Bur Applicable: ϕ 2.334~2.35mm
- Water Pressure: 200Kpa(2.0 bar)
- Noise: \leq 65dB



Rose 202P-M4套装



2CAP-FG头/Head 2CAP头/Head

《可灵活互换》
Can be flexibly interchanged



2CAP-FG
2CAP

BEING
Medical Equipment



产品型号 Model	Rose 202-M4	Rose 202-M4	Rose 202-M4	Rose 202-M4
货号 Order Number	2CAP-FG	2CAP	2SH	2AM-M4/B2
机身 Body	铜 Copper	铜 Copper	铜 Copper	铜 Copper
机型 Handpiece Type	低速弯机 Low Speed Contra Angle	低速弯机 Low Speed Contra Angle	低速直机 Straight Handpiece	低速马达 Low Speed Air Motor
冷却系统 Cooling System	内水道 Internal Water Spray	内水道 Internal Water Spray	内水道 Internal Water Spray	内水道 Internal Water Spray
齿轮传动比 Gear Ratio	1:1	1:1	1:1	1:1
噪音 Noise	\leq 50dB	\leq 50dB	\leq 44dB	\leq 65dB
转速 Speed	22,000~27,000rpm	22,000~27,000rpm	22,000~27,000rpm	22,000~27,000rpm
按压式换针 Push Button Bur Change	●	●	○	○
夹针式换针 Screw Type Bur Change	○	○	●	○
连接方式 Connection	E型接口 E Type	E型接口 E Type	E型接口 E Type	2孔/4孔 2 Holes/4 Holes

Rose Series

低速涡轮牙科手机

Low Speed Kit

- 产品描述: E型气动涡轮低速手机套装, 传动比率1:1, 外水道冷却系统
- 气 压: 245~392Kpa(2.5~4.0 kgf/cm²)
- 转 速: 22,000~27,000rpm
- 适用车针: φ2.334~2.35mm
- 水 压: 200Kpa(2.0 bar)
- 噪 音: ≤65dB
- Description: E type air turbine low speed handpiece kits Ratio1:1.External water spray system
- Air Pressure: 245~392Kpa(2.5~4.0 kgf/cm²)
- Rotation: 22,000~27,000rpm
- Bur Applicable: φ2.334~2.35mm
- Water Pressure: 200Kpa(2 bar)
- Noise: ≤65dB



Rose 201P-M4套装



产品型号 Model	Rose 201-M4	Rose 201-M4	Rose 201-M4	Rose 201-M4
货号 Order Number	1CAP 2	1SH 2	1SH-N	1AM-M4/B2
机身 Body	不锈钢 Stainless Steel	铝 Aluminum	铝 Aluminum	铝 Aluminum
机型 Handpiece Type	低速弯机 Low Speed Contra Angle	低速直机 Straight Handpiece	低速直机 Straight Handpiece	低速马达 Low Speed Air Momtor
冷却系统 Cooling System	外水道 External Water Spray	外水道 External Water Spray	外水道 External Water Spray	外水道 External Water Spray
齿轮传动比 Gear Ratio	1:1	1:1	1:1	1:1
噪音 Noise	≤60dB	≤50dB	≤50dB	≤65dB
转速 Speed	22,000~27,000rpm	22,000~27,000rpm	22,000~27,000rpm	22,000~27,000rpm
按压式换针 Push Button Bur Change	●	○	○	○
夹针式换针 Screw Type Bur Change	○	●	●	○
螺纹锁针 Snap on/Screw-in Type	○	○	○	○
连接方式 Connection	E型接口 E Type	E型接口 E Type	E型接口 E Type	2孔/4孔 2 Holes/4 Holes

Rose Series

低速涡轮牙科手机

Low Speed Kit

- 产品描述: E型气动涡轮低速手机套装, 传动比率1:1, 外水道冷却系统
- 气压: 245~392Kpa(2.5~4.0 kgf/cm²)
- 转速: 22,000~27,000rpm
- 适用车针: φ2.334~2.35mm
- 水压: 200Kpa(2.0 bar)
- 噪音: ≤65dB
- Description: E type air turbine low speed handpiece kits Ratio1:1.External water spray system
- Air Pressure: 245~392Kpa(2.5~4.0 kgf/cm²)
- Rotation: 22,000~27,000rpm
- Bur Applicable: φ2.334~2.35mm
- Water Pressure: 200Kpa(2.0 bar)
- Noise: ≤65dB



Rose 201-M4套装

BEING
Medical Equipment

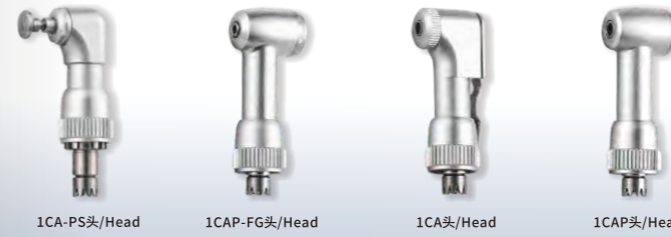

1CA-PS头/Head 1CAP-FG头/Head 1CA头/Head 1CAP头/Head

机头/机身可互换
head / body exchangeable



1CA-PS 1CAP-FG 1CA 1CAP



产品型号 Model	Rose 201-M4	Rose 201-M4	Rose 201-M4	Rose 201-M4	Rose 201-M4	Rose 201-M4
货号 Order Number	1CA-PS	1CAP-FG	1CA	1CAP	1SH	1AM-M4/B2
机身 Body	铝 Aluminum	铝 Aluminum	铝 Aluminum	铝 Aluminum	铝 Aluminum	铝 Aluminum
机型 Handpiece Type	抛光弯机 Polishing Contra Angle	高速弯机 Highspeed Contra Angle	低速弯机 Low Speed Contra Angle	按压低速弯机 Push Button Low Speed Contra Angle	低速直机 Straight Handpiece	低速马达 Low Speed Air Momtor
冷却系统 Cooling System	外水道 External Water Spray	外水道 External Water Spray	外水道 External Water Spray	外水道 External Water Spray	外水道 External Water Spray	外水道 External Water Spray
齿轮传动比 Gear Ratio	1:1	1:1	1:1	1:1	1:1	1:1
噪音 Noise	≤60dB	≤60dB	≤60dB	≤60dB	≤50dB	≤65dB
转速 Speed	22,000~27,000rpm	22,000~27,000rpm	22,000~27,000rpm	22,000~27,000rpm	22,000~27,000rpm	22,000~27,000rpm
按压式换针 Push Button Bur Change	○	●	○	●	○	○
夹针式换针 Screw Type Bur Change	○	○	●	○	●	○
螺纹锁针 Snap on/Screw-in Type	●	○	○	○	○	○
连接方式 Connection	E型接口 E Type	E型接口 E Type	E型接口 E Type	E型接口 E Type	E型接口 E Type	2孔/4孔 2 Holes/4 Holes

牙科弯手机

匠心制造迷你头1:5增速弯机!
Mini-Head Increasing

更小、更精准!

• 小机头
Small Head

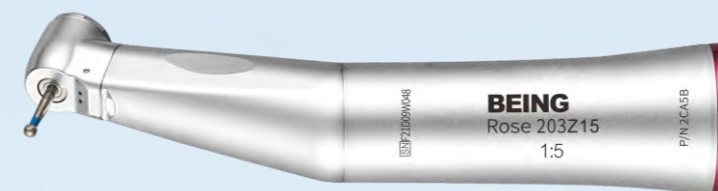

Fiber Optic



型号 : Rose 203Z15 Model	机头尺寸: $\phi 9.7 \times 12\text{mm}$ Head Size	转速传动比1:5 Speed Transmission Ratio	产品描述 Description
货号 : 2CA5B Order Number	适用车针: $\phi 1.59 \times 1.60\text{mm}$ Bur Applicable		· 增速1:5 · 按压换针式 · 单点喷水 Increasing 1:5 Push Button Single Spray
功能概述/Functional Overview			· 内水道冷却系统 Internal Water Spray System

光纤 /Fiber Optic

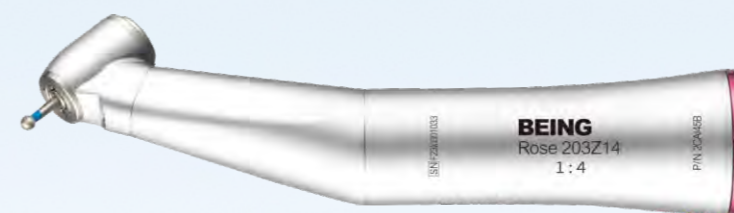

Fiber Optic



型号 : Rose 203Z14 Model	适用车针: $\phi 1.59 \sim 1.60\text{mm}$ Bur Applicable	转速传动比1:4 Speed Transmission Ratio	产品描述 Description
货号 : 2CAI45B Order Number			· 增速1:4 · 按压换针式 · 三点喷水 Increasing 1:4 Push Button Triple Spray
功能概述/Functional Overview			· 内水道冷却系统 Internal Water Spray System

光纤 /Fiber Optic



Fiber Optic



型号 : Rose 203Z14 Model	适用车针: $\phi 1.59 \sim 1.60\text{mm}$ Bur Applicable	转速传动比1:4 Speed Transmission Ratio	产品描述 Description
货号 : 1CAI45B Order Number			· 增速1:4 · 按压换针式 · 三点喷水 Increasing 1:4 Push Button Triple Spray
功能概述/Functional Overview			· 外水道冷却系统 External Water Spray System

光纤 /Fiber Optic



Fiber Optic



型号 : Rose 203Z15 Model	适用车针: $\phi 1.59 \sim 1.60\text{mm}$ Bur Applicable	转速传动比1:5 Speed Transmission Ratio	产品描述 Description
货号 : 1CAI5B Order Number			· 增速1:5 · 按压换针式 · 三点喷水 Increasing 1:5 Push Button Triple Spray
功能概述/Functional Overview			· 外水道冷却系统 External Water Spray System

光纤 /Fiber Optic

牙科弯手机

Ti 钛合金增速弯机

Titanium Increasing Contra Angle

高硬度 轻量化 耐腐蚀

High Hardnes、Lightweight、Preservative



202CA15-04-00W

型号 : Rose 203Z15 Model	适用车针 : $\phi 1.59\sim 1.60\text{mm}$ Bur Applicable	产品描述 Description
货号 : Z15B(TC) Order Number	转速传动比1:5 Speed Transmission Ratio	· 增速1:5 · 按压换针式 · 三点喷水 Increasing 1:5 Push Button Triple Spray · 钛合金机身 · 钛合金机头 · 内水道冷却系统 Titanium Alloy Body Titanium Alloy Head Internal Water Spray System
功能概述/Functional Overview		光纤/Fiber Optic



202CA15-04-00W

型号 : Rose 203Z15 Model	适用车针 : $\phi 1.59\sim 1.60\text{mm}$ Bur Applicable	产品描述 Description
货号 : Z15B Order Number	转速传动比1:5 Speed Transmission Ratio	· 增速1:5 · 按压换针式 · 三点喷水 Increasing 1:5 Push Button Triple Spray · 内水道冷却系统 Internal Water Spray System
功能概述/Functional Overview		光纤/Fiber Optic



202CA15-04-00W

型号 : Rose 203Z15 Model	适用车针 : $\phi 1.59\sim 1.60\text{mm}$ Bur Applicable	产品描述 Description
货号 : Z15 Order Number	转速传动比1:5 Speed Transmission Ratio	· 增速1:5 · 按压换针式 · 三点喷水 Increasing 1:5 Push Button Triple Spray · 内水道冷却系统 Internal Water Spray System
功能概述/Functional Overview		光纤/Fiber Optic



202CA15-04-00W

型号 : Rose 203Z15 Model	适用车针 : $\phi 1.59\sim 1.60\text{mm}$ Bur Applicable	产品描述 Description
货号 : 1CA15 Order Number	转速传动比1:5 Speed Transmission Ratio	· 增速1:5 · 按压换针式 · 三点喷水 Increasing 1:5 Push Button Triple Spray · 外水道冷却系统 External Water Spray System
功能概述/Functional Overview		光纤/Fiber Optic

牙科弯手机

20:1种植弯机

Contra Angle:Reduction Implant

80N·cm

最大扭矩/Torque Up

外水道冷却系统
External water spray

✓ 抖动小, 扭力大
Steady rotation, Super Torque

✓ 按压式, 机头可拆卸与KAVO通配
Push button Type, Head Moveable And Compatible With KAVO

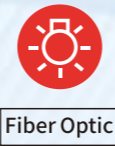

Fiber Optic

BEING
Medical Equipment



型号 : Rose 203J201 Model	适用车针: ϕ 2.334~2.35mm Bur Applicable	产品描述 : 20:1减速弯机 · 按压换针式 · 外水道喷水 Description : 20:1 Reduction Push Button External Water Spray
货号 : B201L Order Number	转速传动比20:1 Speed Transmission Ratio	最大扭矩: 80N·cm Torque Up
功能概述/Functional Overview		光纤 /Fiber Optic



型号 : Rose 203J201 Model	适用车针: ϕ 2.334~2.35mm Bur Applicable	产品描述 : 20:1减速弯机 · 按压换针式 · 外水道喷水 Description : 20:1 Reduction Push Button External Water Spray
货号 : B201 Order Number	转速传动比20:1 Speed Transmission Ratio	最大扭矩: 80N·cm Torque Up
功能概述/Functional Overview		



型号 : Rose 203J201 Model	适用车针: ϕ 2.334~2.35mm Bur Applicable	产品描述 : 20:1减速弯机 · 按压换针式 · 外水道喷水 Description : 20:1 Reduction Push Button External Water Spray
货号 : 1CAR20 Order Number	转速传动比20:1 Speed Transmission Ratio	最大扭矩: 80N·cm Torque Up
功能概述/Functional Overview		



型号 : Rose 203J201 Model	适用车针: ϕ 2.334~2.35mm Bur Applicable	产品描述 : 20:1减速弯机 · 按压换针式 · 外水道喷水 Description : 20:1 Reduction Push Button External Water Spray
货号 : 1CAR20B-N Order Number	转速传动比20:1 Speed Transmission Ratio	最大扭矩: 80N·cm Torque Up
功能概述/Functional Overview		光纤 /Fiber Optic

牙科弯手机

减速弯机

Contra Angle:Reduction

✓ 内水道喷水
Internal water spray

✓ 按压式
Push button type

✓ 光纤
Fiber Optic

✓ 可选机头
Head Optional



· 机头可拆卸
Head Removable

型号 : Rose 203J41
Model
货号 : 2CAR4B/2CAR4
Order Number
适用车针 : $\phi 2.334\sim 2.35\text{mm}$
Bur Applicable
转速传动比4:1
Speed Transmission Ratio
产品描述
Description
· 4:1减速弯机
4:1 Reduction
· 按压换针式
Push Button
· 光纤/非光纤
Fiber Optic/Non
Fiber Optic
· 内水道喷水
Internal Water Spray

功能概述/Functional Overview



光纤/非光纤
Fiber Optic/No Fiber Optic

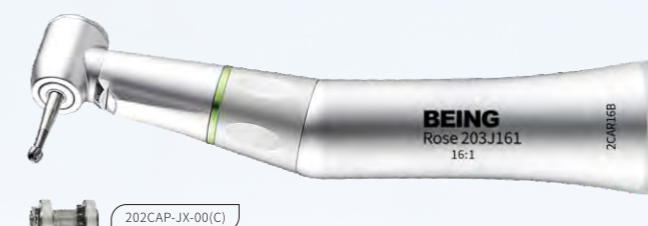

· 机头可拆卸
Head Removable

型号 : Rose 203J161
Model
货号 : 2CAR16B/2CAR16
Order Number
适用车针 : $\phi 2.334\sim 2.35\text{mm}$
Bur Applicable
转速传动比16:1
Speed Transmission Ratio
产品描述
Description
· 16:1减速弯机
16:1 Reduction
· 按压换针式
Push Button
· 光纤/非光纤
Fiber Optic/Non
Fiber Optic
· 内水道喷水
Internal Water Spray

功能概述/Functional Overview



光纤/非光纤
Fiber Optic/No Fiber Optic

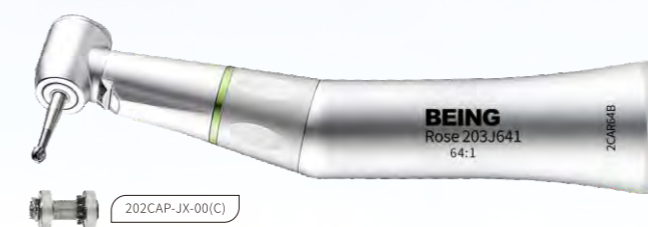

· 机头可拆卸
Head Removable

型号 : Rose 203J641
Model
货号 : 2CAR64B/2CAR64
Order Number
适用车针 : $\phi 2.334\sim 2.35\text{mm}$
Bur Applicable
转速传动比64:1
Speed Transmission Ratio
产品描述
Description
· 64:1减速弯机
64:1 Reduction
· 按压换针式
Push Button
· 光纤/非光纤
Fiber Optic/Non
Fiber Optic
· 内水道喷水
Internal Water Spray

功能概述/Functional Overview



光纤/非光纤
Fiber Optic/No Fiber Optic



· 机头可拆卸
Head Removable

型号 : Rose 203J1281
Model
货号 : 2CAR128B/2CAR128
Order Number
适用车针 : $\phi 2.334\sim 2.35\text{mm}$
Bur Applicable
转速传动比128:1
Speed Transmission Ratio
产品描述
Description
· 128:1减速弯机
128:1 Reduction
· 按压换针式
Push Button
· 光纤/非光纤
Fiber Optic/Non
Fiber Optic
· 内水道喷水
Internal Water Spray

功能概述/Functional Overview



光纤/非光纤
Fiber Optic/No Fiber Optic

通用机头
Heads For General Application



适用2.35mm低速车针
360°旋转
Burs 2.35mm, Push button
360° rotation
Recommended Max 40,000rpm

202CAP-JT-00



适用2.35mm低速车针
360°旋转
Burs 2.35mm, Push button
360° rotation
Recommended Max 20,000rpm
2:1 Reduction

202CAP-JT2-00



适用1.60mm高速车针
360°旋转
Burs 1.60mm, Push button
360° rotation
Recommended Max 40,000rpm

202CAP-JT-00-FG

抛光机头
Heads For Polish Application



适用螺纹抛光杯/刷
360°旋转
For Screw-in cups/brushes
360° rotation
Recommended Max 4000rpm

202POL-S-00

根管治疗机头
Heads For Endodontic Application



适用机用锉, 按压式
往复60°转动
For engine file, Push button
60° Reciprocating Motion
Recommended Max 3000rpm

202EN60-JT-00



适用手动锉, 按压式
上下运动
For hand file, Push button
Vertical Reciprocating Motion
Recommended Max 3000rpm

202UD04-JT-00

可配机头
Head Optional



可与KAVO通用
Compatible With KAVO heads

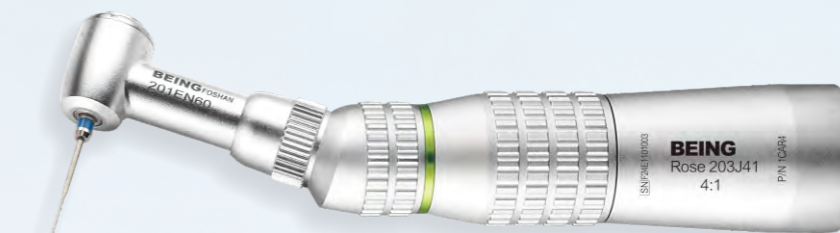

201CAP-A3

适用机用锉, 按压式
适用2.35mm低速车针
360°旋转

For engine file, Push button
Burs 2.35mm
360° rotation
Recommended Max 3000rpm

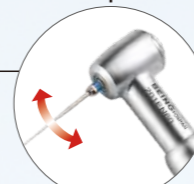

201EN60

适用机用锉, 按压式
往复60°转动

For engine file, Push button
60° Reciprocating Motion
Recommended Max 3000rpm

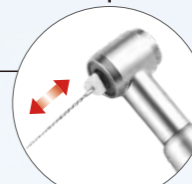

201UD04H

适用手动锉, 按压式
上下运动

For hand file, Push button
Vertical Reciprocating Motion
Recommended Max 3000rpm

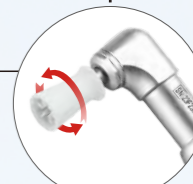

201POL-S-00

适用螺纹抛光杯/刷
360°旋转

For Screw-in cups/brushes
360° rotation
Recommended Max 4000rpm



201CAP-A3

适用机用锉, 按压式
适用2.35mm低速车针
360°旋转



For engine file, Push button
Burs 2.35mm
360° rotation
Recommended Max 3000rpm

根管弯机头

Endo Motor Contra Angle

These Heads are compatible with almost all brands of ENDO MOTOR (Cord & Cordless), such as NSK, Dentsply etc.

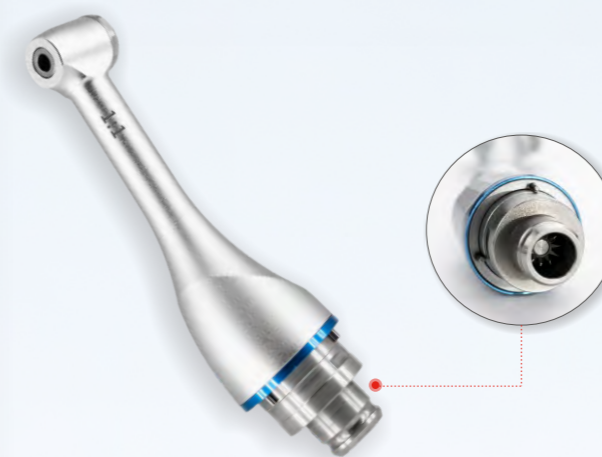

型号/Model: 201WR 1
1:1 等速, 按压迷你头
1:1 direct drive
Mini Head, Push button

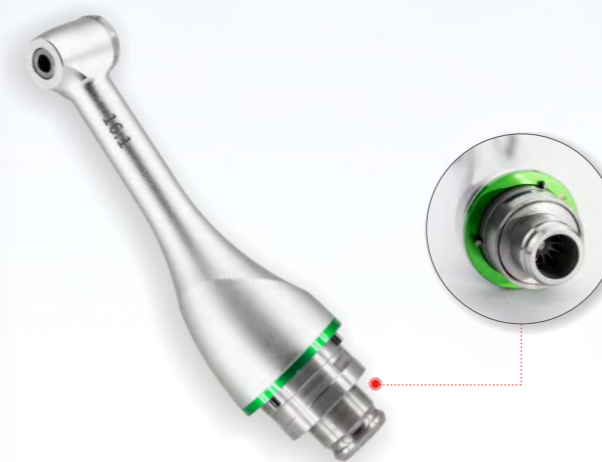

型号/Model: 201WR 16
16:1 减速, 按压迷你头
16:1 Reduction
Mini Head, Push button

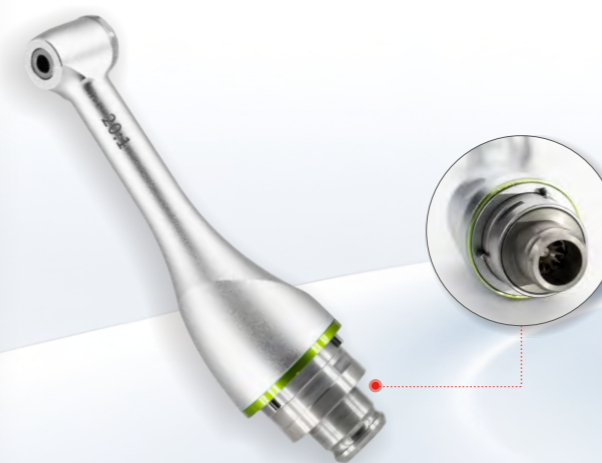

型号/Model: 201WR 20
20:1 减速, 按压迷你头
20:1 Reduction
Mini Head, Push button



型号 : Rose 203J41 Model	适用车针: ϕ 2.334~2.35mm Bur Applicable	产品描述 Description
货号 : 1CAR4 Order Number	转速传动比4:1 Speed Transmission Ratio	· 4:1减速弯机 · 按压换针式 4:1 Reduction Push Button
功能概述/Functional Overview		

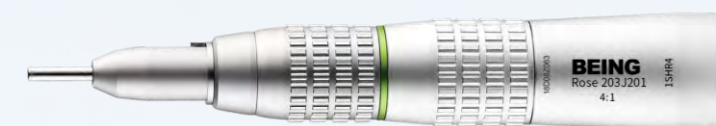

型号 : Rose 203J201 Model	适用车针: ϕ 2.334~2.35mm Bur Applicable	产品描述 Description
货号 : 1SHR4 Order Number	转速传动比4:1 Speed Transmission Ratio	· 4:1减速直机 · 夹针换针式 4:1 Reduction Screw Type
功能概述/Functional Overview		



型号 : Rose 203J161 Model	适用车针: ϕ 2.334~2.35mm Bur Applicable	产品描述 Description
货号 : 1CAR16 Order Number	转速传动比16:1 Speed Transmission Ratio	· 16:1减速弯机 · 按压换针式 16:1 Reduction Push Button
功能概述/Functional Overview		



型号 : Rose 203J641 Model	适用车针: ϕ 2.334~2.35mm Bur Applicable	产品描述 Description
货号 : 1CAR64 Order Number	转速传动比64:1 Speed Transmission Ratio	· 64:1减速弯机 · 按压换针式 64:1 Reduction Push Button
功能概述/Functional Overview		

牙科低压电动马达 Dental Electric Motor

Tabletop Type 便携式

Touch Control Panel, Easy Operation
医生操作更简便, 轻触即可完成

- 转速/Speed: 2000-40000rpm;
- 噪音/Noise: ≤60dB;
- 扭矩/Torque: 3.4Ncm;
- 重量/Weight: 70g
- 内水道喷水, E型ISO国际标准接口
Internal Water Spray, E-type ISO Standard Connector
- 型号/Model: ROSE CLINIC2 (国外型号)
ROSE CLINIC3 (国内型号)



牙科低压电动马达 Dental Electric Motor

Built-In Type 内置式

型号/Model: ROSE CLINIC2 (国外型号)
ROSE CLINIC3 (国内型号)



可和KAVO电动马达互换
通用KAVO马达型号701, 702
Compatible with KAVO's
Electric Micromotor model 701, 702

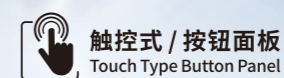

Tulip Series

牙科光固化机(LED) Dental Curing Light(LED)

- 容量: 2000mAh, 电池带有过压、过流和短路保护
 - 光强: >1200mW/cm², 最高可达到3100mW/cm²
 - 波长: 385-515nm
 - 外形尺寸: φ22.5x211mm
 - 手柄净重: 110g
- Capacity: 2000mAh, battery with overvoltage, overcurrent and short circuit protection
 - LUMINOUS INTENSITY: >1200mW/cm², Max Reach 3100mW/cm²
 - Wavelength: 385-515nm
 - Dimensions: φ22.5x211mm
 - Handle net weight: 110g



TULIP 100A (铝Aluminum)

磁吸底座
Magnetic base

BEING
Medical Equipment

TULIP 101A



2000Mah 电池
2000Mah battery



过压保护
Overvoltage protection



过流保护
Overcurrent protection



短路保护
Short circuit protection



充电座颜色可选:
Charging station color optional

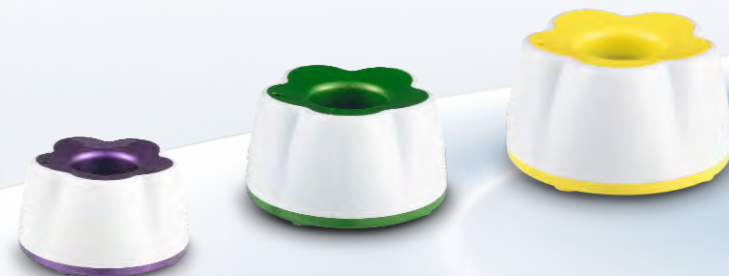

TULIP 200A/200B

光强最高可达到3100mW/cm²
Intensity can reach 3100mW/cm²

- 光 强: >1200mW/cm²(5w)最高可达3100mW/cm²
- 工作电压: 100~240V(AC), 50~60HZ
- 电池容量: 2200Mah
- 时间可设置: 0-60S
- 波 长: 385-515nm
- 电池类型: 锂电
- 级 别: 普通、B型、间歇式

- LUMINOUS INTENSITY: >1200mW/cm² (5W); Max3100mW/cm²
- WORKING VOLT: 100~240V(AC), 50~60HZ
- BATTERY CAPACITY: 2200Mah
- TIMING SET UP: 0-60S
- WAVE LENGTH: 385-515nm
- BATTERY TYPE: LITHIUM BATTERY
- CLASS: Ordinary、B type、Intermittent working

四种治疗模式 Four treatment modes

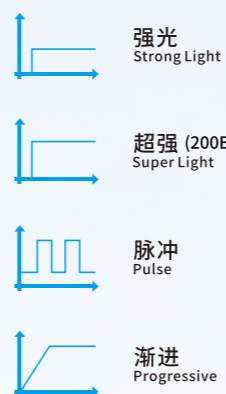

TULIP 200A



TULIP 200B

口腔数字观察仪 Oral Camera

Wi-Fi 扫码17寸口腔观察仪一体机
WIFI 17 Inch Intraoral Camera All-In-One

Azalea ST700(A)

参数:

- 输 入: AHD 1280*1024
- 解 析 度: 4K 百万像素
- 光 源: 6颗白色LED
- 显示分辨率: 1280*1024
- 工作电压: DC 12V
- 输出方式: 17寸屏
- 储 存: U盘

Specifications:

- Input: AHD 1280*1024
- Resolution: 4K Mega Pixels
- Light: 6White LED
- Display Resolution: 1280*1024
- Working Voltage: DC 12V
- Output Mode: 17 Inch Screen
- Storage: USB Disk



全焦段4K高清镜头



(有线无变焦)

变焦&无变焦双配置, 对应价位, 按需所选

图片直接保存到手机相册可以直接发到患者微信, 或客户也可直接扫码下载

口腔观察仪+21.5寸超高清液晶屏一体机

Intraoral Camera +21.5 Inch Ultra HD LED Monitor All-In-One

Azalea ST700(C)

(有线无变焦)

变焦&无变焦双配置, 对应价位, 按需所选



参数:

- 输 入: AHD 1920*1080
- 解 析 度: 1300万像素13.0
- 光 源: 6颗白色LED
- 显示分辨率: 1920*1080
- 工作电压: DC 12V
- 输出方式: 21.5寸屏
- 储 存: U盘

Specifications:

- Input: AHD 1920*1080
- Resolution: 13 Million Pixels
- Light: 6White LED
- Display Resolution: 1920*1080
- Working Voltage: DC 12V
- Output Mode: 21.5 Inch Screen
- Storage: USB Disk

技工室无碳刷电动马达 批量定制

Dental Laboratory Electric Motor

PUMA 3000

特点:

无刷电子换相式电机, 免维护, 节约生产成本, 外型美观, 体积小, 极低音, 马达工作不发热, 动力强劲, 比有碳刷电机拥有不可比拟的超强动力。无论空载或者负载, 无刷电机的转速和扭矩都是恒定不变的。

Feature:

Brushless electronic control micromotor, maintenance-free, cost-effective, elegance, tiny shape for easy handling, minimal noise and heat, super powerful drive, supply invariable speed and torque no matter load or not load.

- | | |
|---|---|
| <ul style="list-style-type: none"> • 转 速: 数码无级调速, 最高可达到40,000rpm • 手机接口: ISO-E型国际标准接口 • 控制方式: 手动/脚踏控制 • 手柄尺寸: L136Xφ22(mm) • 输入电压: 22V-24V AC/DC. • 扭 矩: 150gf.cm • 手柄重量: 120g • 功 率: 30W | <ul style="list-style-type: none"> • Rotation speed: Digital stepless speed regulating. Max40,000rpm • Connect: ISO-E type international connector • Control type: Manul/foot control • Dimensions: L136Xφ22(mm) • Voltage: 22V-24V AC/DC. • Torque: 150gf.cm • Weight: 120g • Power: 30W |
|---|---|



PUMA 4000

技工室用一体式无刷电动马达有手控、脚控两种控制方式。

- **转 速:** 2000-40000rpm, 数码无级调速
- **输入电压:** 100-230VAC
- **手柄尺寸:** L150Xφ25(mm)
- **手柄重量:** 220g
- **功 率:** 100W

大扭矩, 恒速转动。

Brushless electrical micromotor for laboratory. manual control, foot control.

- **Rotation speed:** 2000-40000rpm, stepless speed regulating.
- **Dimensions:** L150Xφ25(mm)
- **Voltage:** 100-230V AC
- **Weight:** 220g
- **Power:** 100W

Super torque, constant speed rotation.



图标说明

ICON NAME

图标/Icon	说明/Name	图标/Icon	说明/Name	图标/Icon	说明/Name
	迷你头 Mini Head		光纤 Fiber Optic		传动比率 1:1 Transmission Ratio 1:1
	小头 Small Head		LED自发光 Self-Luminous		传动比率 1:5 Transmission Ratio 1:5
	标准头 Standard Head		开放式机芯 Open Cartridge		传动比率 4:1 Transmission Ratio 4:1
	大头 Torque Head		筒夹式机芯 Folder Cartridge		传动比率 16:1 Transmission Ratio 16:1
	单孔喷水 Single Spray		2孔连接 2-Holes Connection		传动比率 20:1 Transmission Ratio 20:1
	三孔喷水 Triple Spray		4孔连接 4-Holes Connection		传动比率 64:1 Transmission Ratio 64:1
	按压式 Push Button		6孔连接 6-Holes Connection		传动比率 128:1 Transmission Ratio 128:1
	锁针式 Screw Type		可在134°C 高温高压下消毒 Can Be Sterilized At 134°C High Temperature and High Pressure		外置水道马达 External Water Spray Air Motor
	快接 Quick Coupling		可热清洗 Heat Washable		内置水道马达 Internal Water Spray Air Motor

功能特点的图标

FUNCTIONAL OVERVIEW MARKING NOTES



只需轻轻一按, 更换车针简单方便, 节省时间, 并能精确定位锁定车针。
With a simple click, changing the burs is easy and convenient, saving time and accurately positioning and locking the burs.

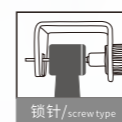

精确定位的功能性锁紧结构, 固定、保持或防止车针。
An effective locking mechanism with precise positioning to secure, hold, or block the burs.



可提供更强的光照强度, 能耗低, 寿命长, 节能环保。
It can provide stronger light intensity, low energy consumption, long life, energy saving and environmental protection.

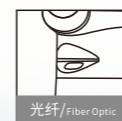

玻璃体光导纤维, 可使治疗的区域变得明朗, 即使反复 高温高压消毒, 性能也不会劣化。
Fiber Optic can enhance the brightness of the treated area. Its performance will not deteriorate even after repeated sterilization with high temperature and high pressure.



钛---被誉为新时代的“航空金属”“海洋金属”“生物金属”, 它强度高, 质感轻, 耐腐蚀, 无重金属析出, 健康, 无毒, 抑菌, 环保。
Titanium---known as the "aviation metal", "marine metal" and "biometal" of the new era, it has high strength, light weight, corrosion resistance, no heavy metal precipitation, healthy, non-toxic, antibacterial and environmental friendly.



抗过热/Anti-overheat
避免高速手机头部灼伤患者的风险, 确保病患的舒适性和安全性/Avoids the risk of high-speed handpiece head burning, ensure patient comfort and safety



自由旋转/Free Rotation
自由旋转更便于手上自由操作。由于采用了灵活和轻巧的旋转快速接头, 提高日常工作的效率/Free rotation makes it easier to operate with your hands. The flexible and lightweight swivel quick connector, improve efficiency in daily work.



P4级轴承/P4 grade bearings
轴承等级是按不同的负荷能力和寿命要求将其分为多个等级, P4级为特高速轴承等级, 适用于超高速、重载、高精度要求的应用。
Bearing grades are categorized based on different load capacities and life requirements. The P4 grade is designed for ultra-high-speed applications with heavy load and high precision requirements.