



















第二十五届全国大学生机器人大赛ROBOCON



图 册

全国大学生机器人大赛 ROBOCON 组委会 2025 年 9 月

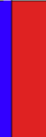
附录1 比赛场地颜色及材质

项目	颜色	材质	R-G-B
启动区 (红队)		多层板, 水性漆	223-34-34
一区 (红队)			250-220-218
启动区 (蓝队)			50-0-255
一区 (蓝队)		金属, 油性漆	128-199-226
长杆架			155-95-0
端头架		多层板, 水性漆	155-95-0
引导线			255-255-255
围栏			155-95-0
二区通道 (红队)			236-162-151
二区通道 (蓝队)			117-175-191
梅花树林 (200mm)		多层板, 水性漆	41-82-16
梅花树林 (400mm)			42-113-56
梅花树林 (600mm)			152-166-80
坡道			192-189-182
三区 (红队)		多层板, 水性漆	250-220-218
三区 (蓝队)			128-199-226
已用兵器区			255-255-0
重试区 (红队)			223-34-34
重试区 (蓝队)			50-0-255
九宫格		底座: 多层板水性漆 架体: 亚克力, 透明 边角: 亚光乙烯基胶带	255-255-25 0-0-0

注: 各项尺寸及规格参与与之相应的附录文档。

附录2 长杆架

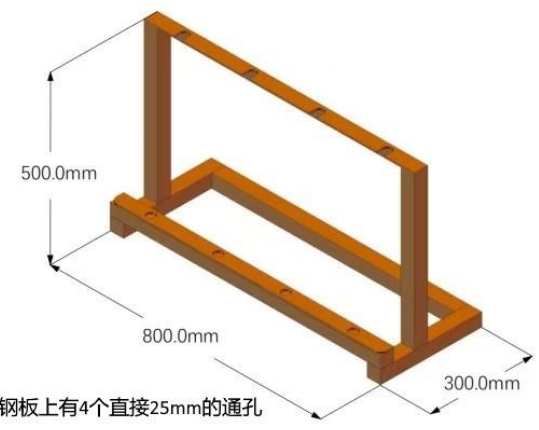
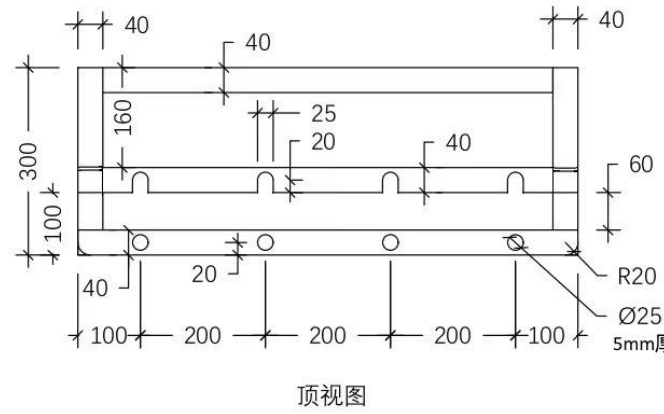
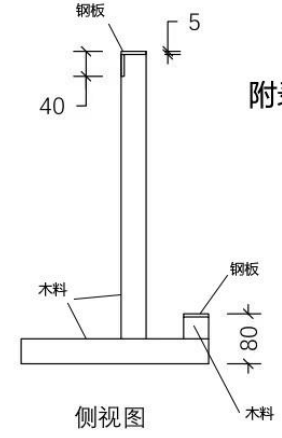
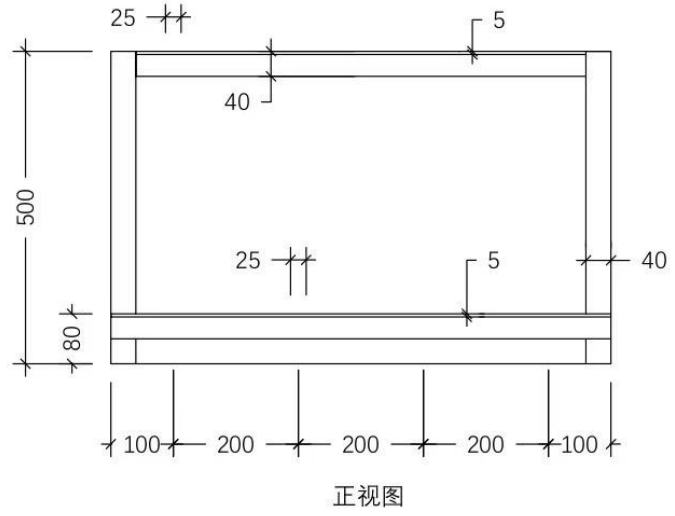

附录3 比赛场地尺寸

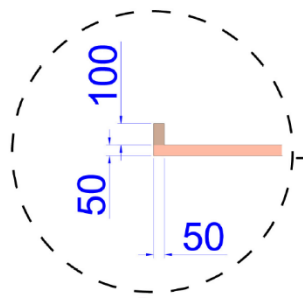

围栏：高100mm，宽50mm

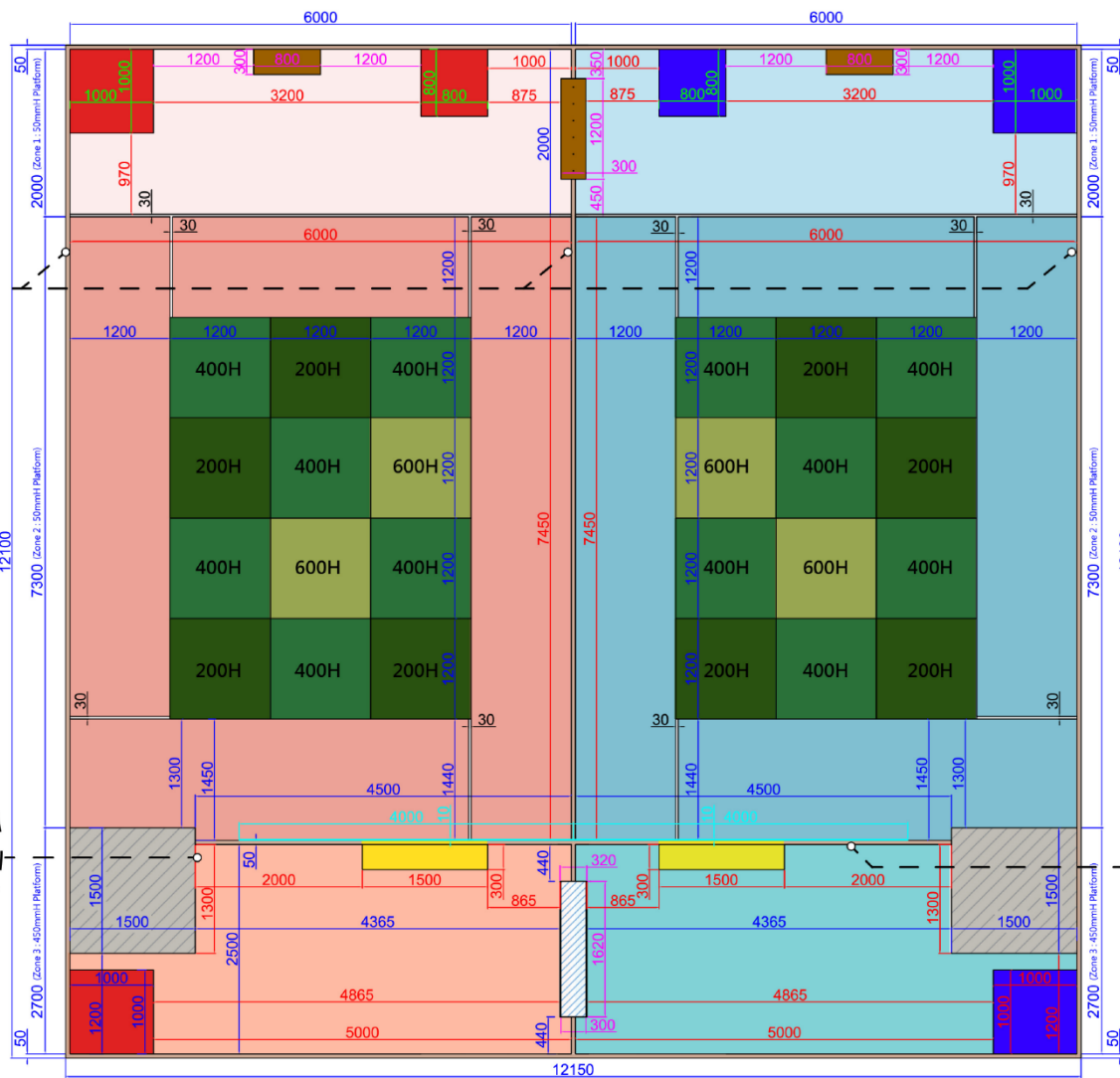
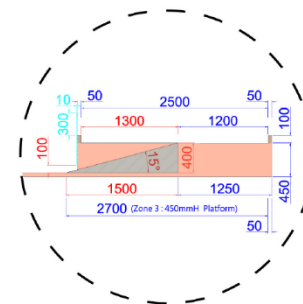

亚克力护栏：厚10mm

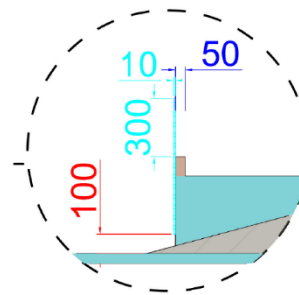

附录4 比赛场地透视

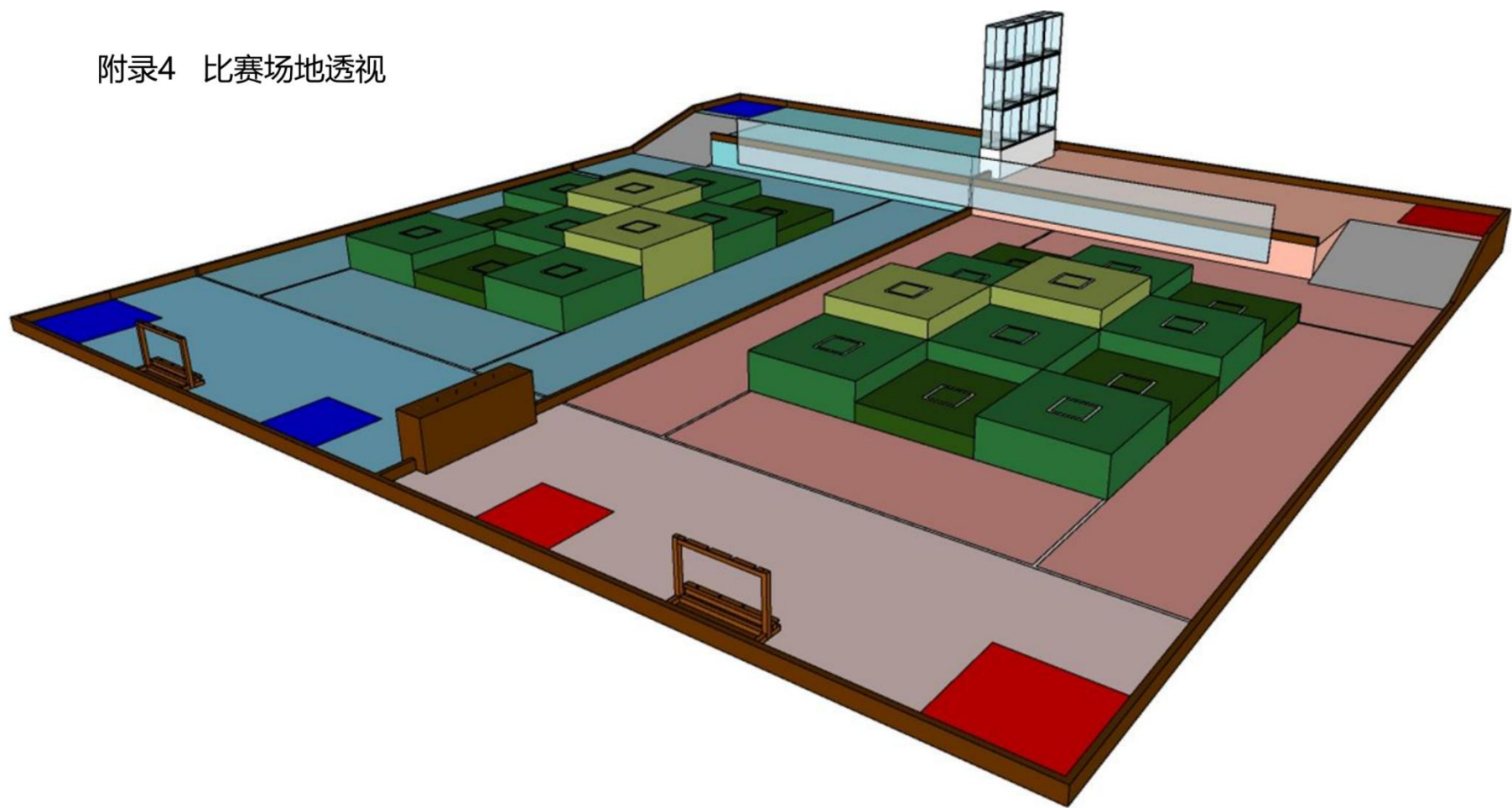

附录5 比赛场地对抗区的护栏

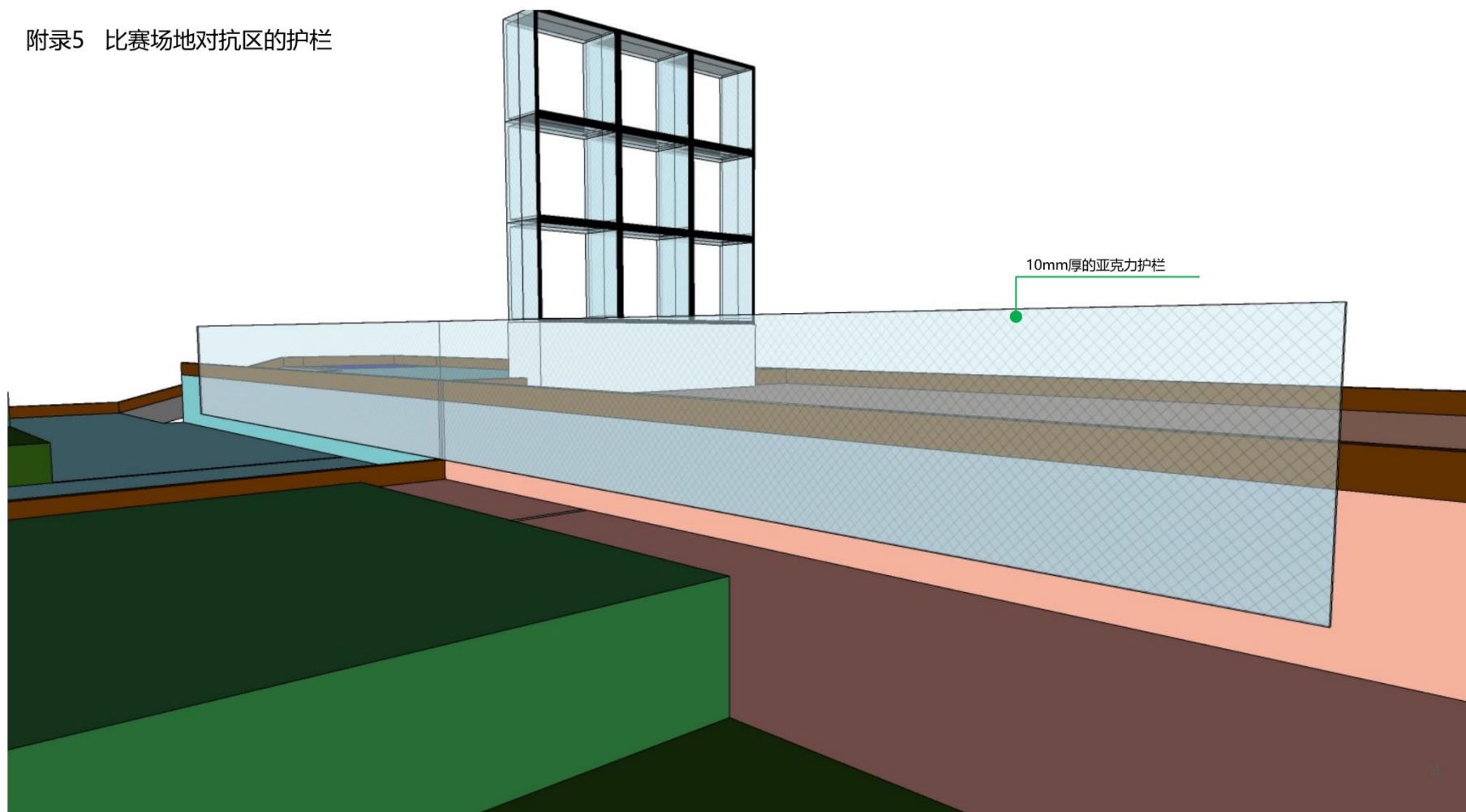

附录6 树林方块

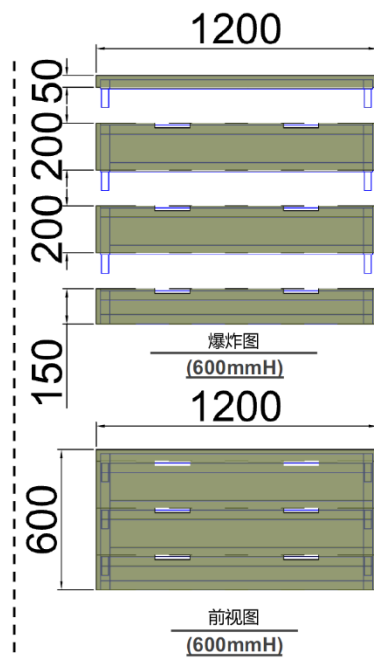
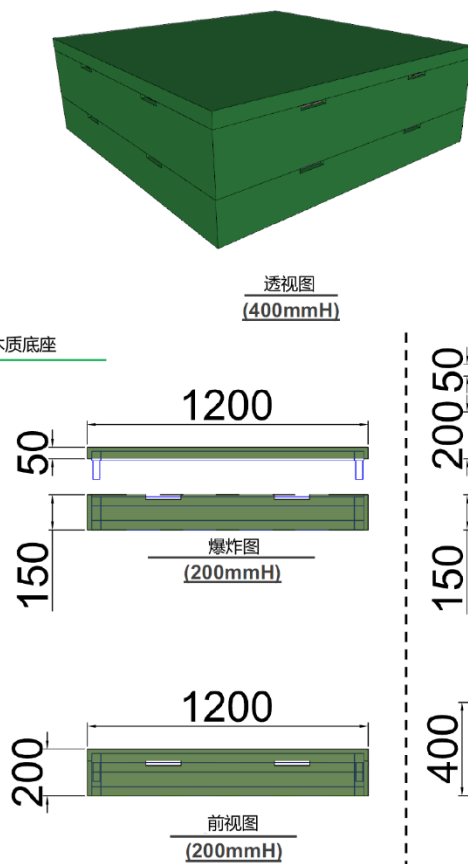
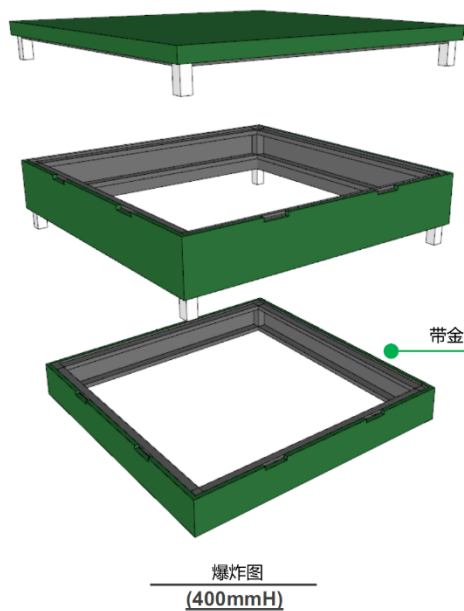

附录7 树林透视图

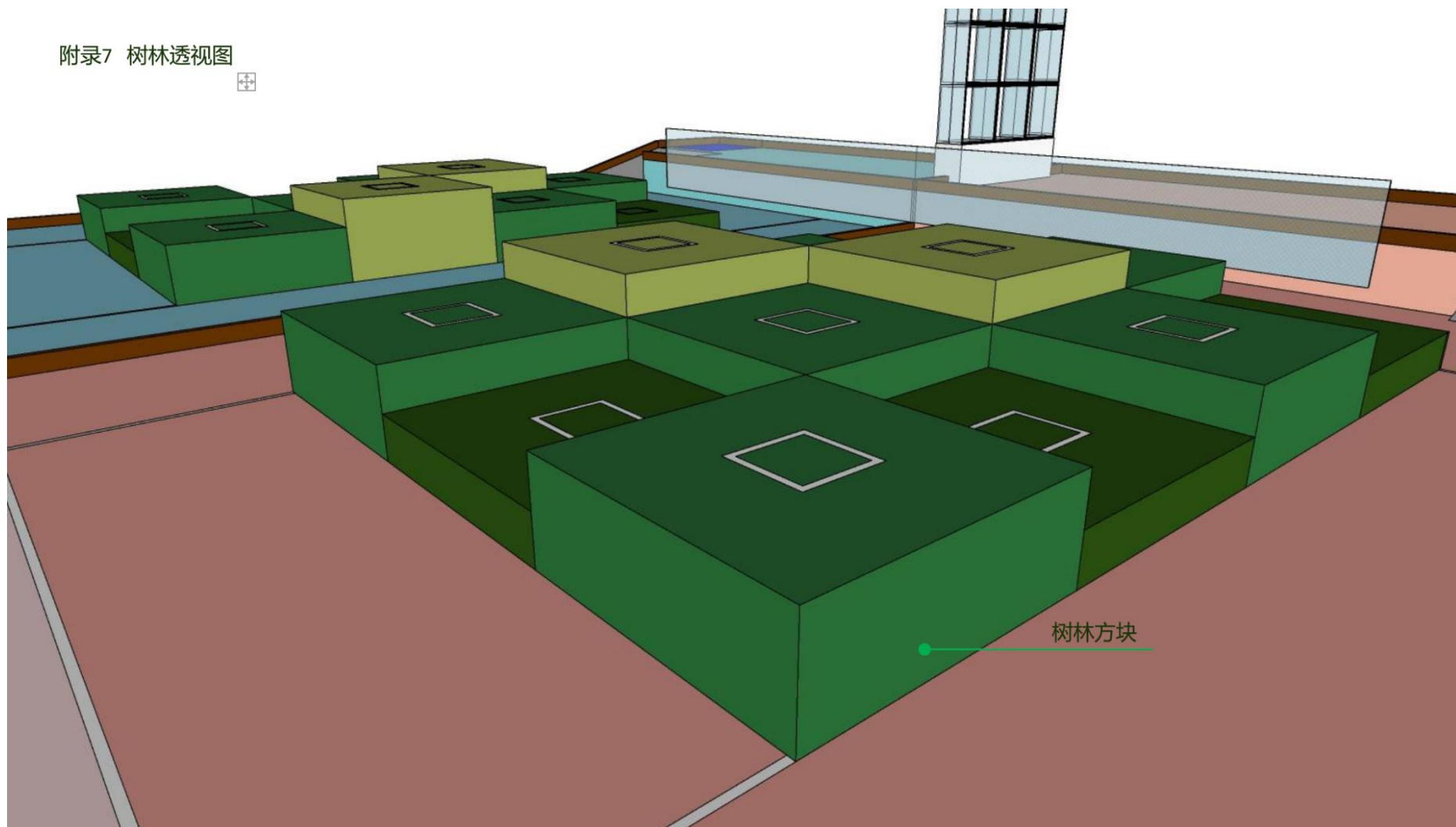

树林方块

附录8-长杆

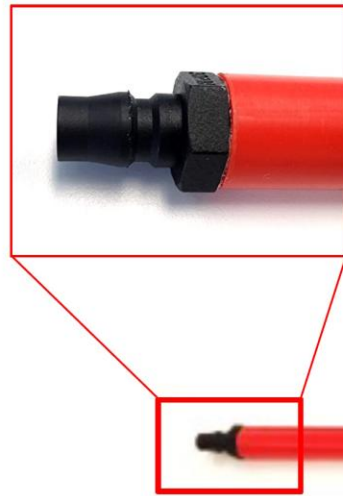

PVC管的壁厚



PVC管的外径



组装的长杆

材料: 粘接了组装接头 (聚甲醛快速接头) 的PVC管

PVC管: 长1000mm, 外径20.3mm ($\pm 1\%$), 壁厚2mm ($\pm 1\%$)

聚甲醛快速接头: 30PM, 重6g

总长: 1007mm ($\pm 0.5\%$) (PVC管+30PM外露部分)

总重: $\sim 195\text{g}$ ($\pm 3\%$)



附录9 端头-拳



组装品名	材质	组装长度	组装重量
端头-拳 (3D printing link)	PLA组件与接头 (塑料快速接头)	128mm (±1%)	85g (±5%)

品名	材料	型号	重量	长度
接头 (快速接头)	聚甲醛	40SM	22g (±5%)	52.5mm (±0.5%)

品名	材质	制作方法	壁厚	填充	螺纹	尺寸 (长宽高)	重量
拳	PLA	3D 打印	1.6	10%	G1/2-14	89x84x50mm (±5%)	63g (±5%)

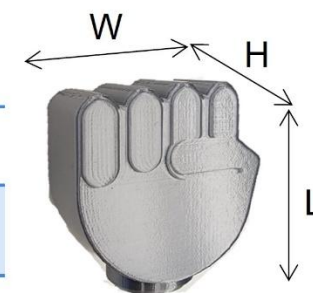



附录10 端头-掌



组装品名	材质	组装长度	组装重量
端头-掌 (3D printing link)	PLA组件与接头 (塑料快速接头)	80mm (±1%)	81g (±5%)

品名	材料	型号	重量	长度
接头 (快速接头)	聚甲醛	40SM	22g (±5%)	52.5mm (±0.5%)

品名	材质	制作方法	壁厚	填充	螺纹	尺寸 (长宽高)	重量
掌	PLA	3D 打印	1.6	10%	G1/2-14	133.6x84x41mm (±5%)	59g (±5%)



附录11 端头-矛尖



组装机名	材质	组装长度	组装重量
端头-矛尖 (3D printing link)	PLA组件与接头 (塑料快速接头)	288mm (±1%)	106g (±5%)

品名	材料	型号	重量	长度
接头 (快速接头)	聚甲醛	40SM	22g (±5%)	52.5mm (±0.5%)

品名	材质	制作方法	壁厚	填充	螺纹	尺寸 (长宽高)	重量
矛头	PLA	3D 打印	1.6	10%	G1/2-14	251x77x35.8mm (±5%)	84g (±5%)



附录12 组装兵器的长度



1148mm ($\pm 0.5\%$)

重量: 280 g ($\pm 3\%$)



1099mm ($\pm 0.5\%$)

重量: 276 g ($\pm 3\%$)



1310mm ($\pm 0.5\%$)

重量: 301 g ($\pm 3\%$)

附录13 长杆架透视图

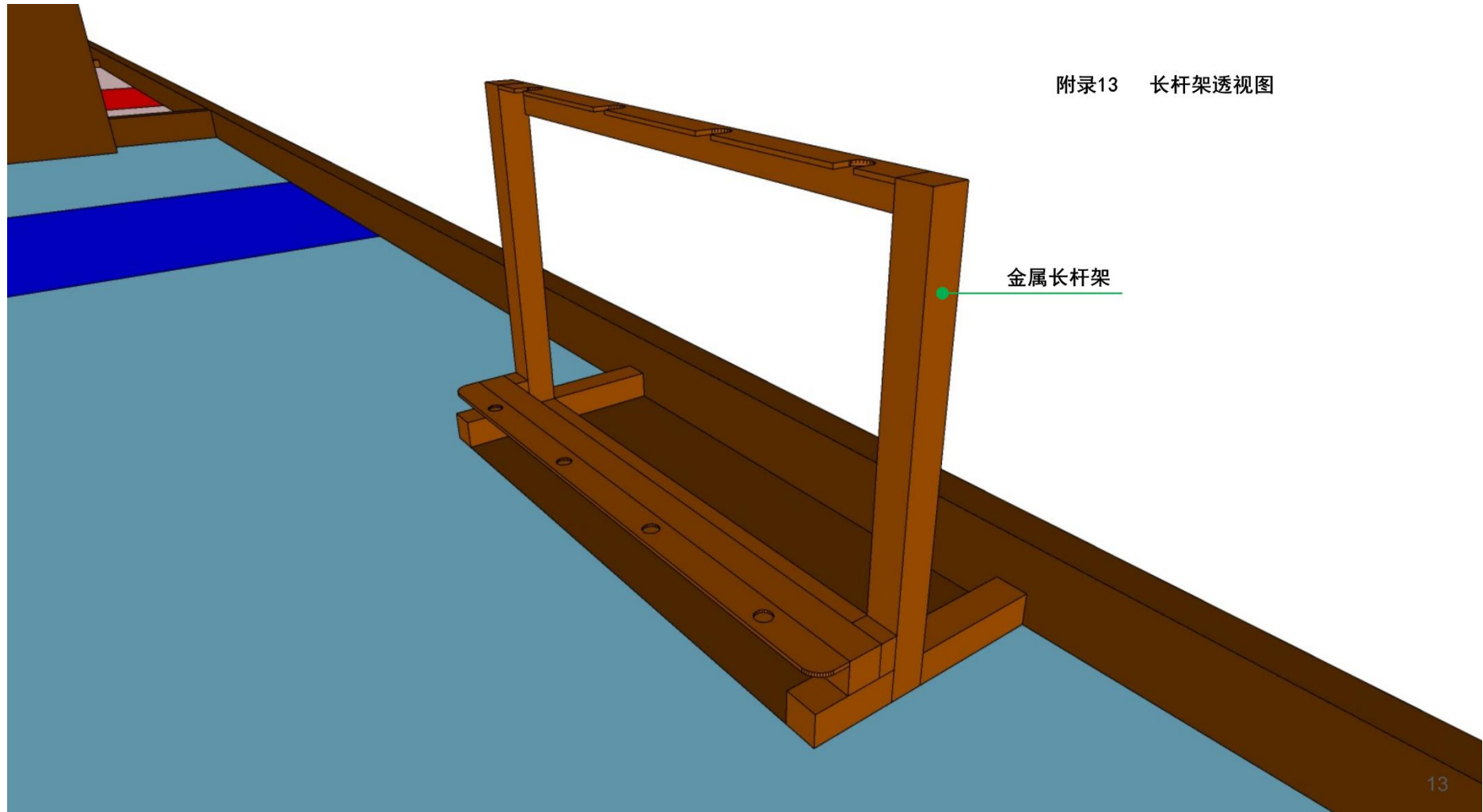

金属长杆架

附录14 端头架

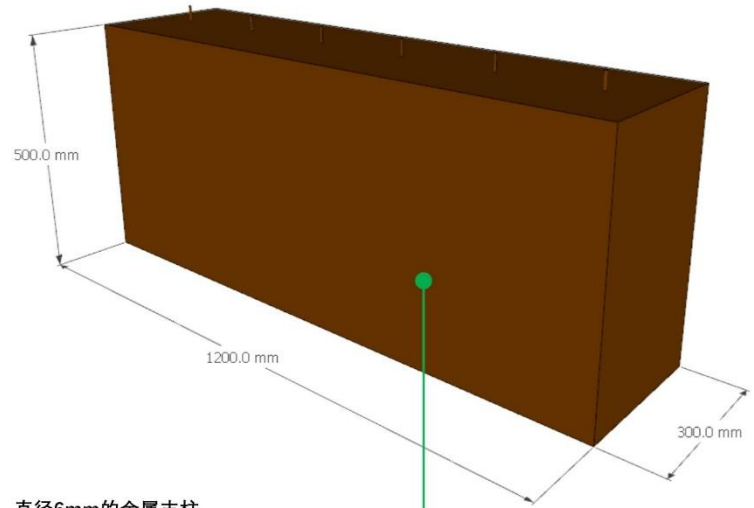
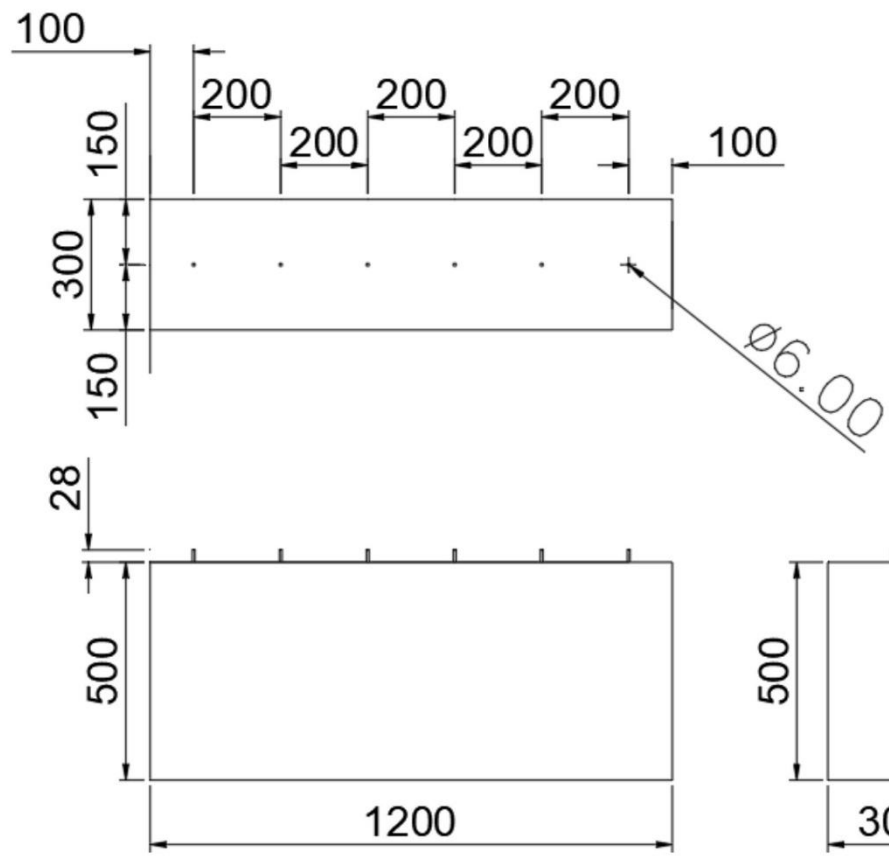

直径6mm的金属支柱

带金属支架的木质底座

附录15 端头架透视图

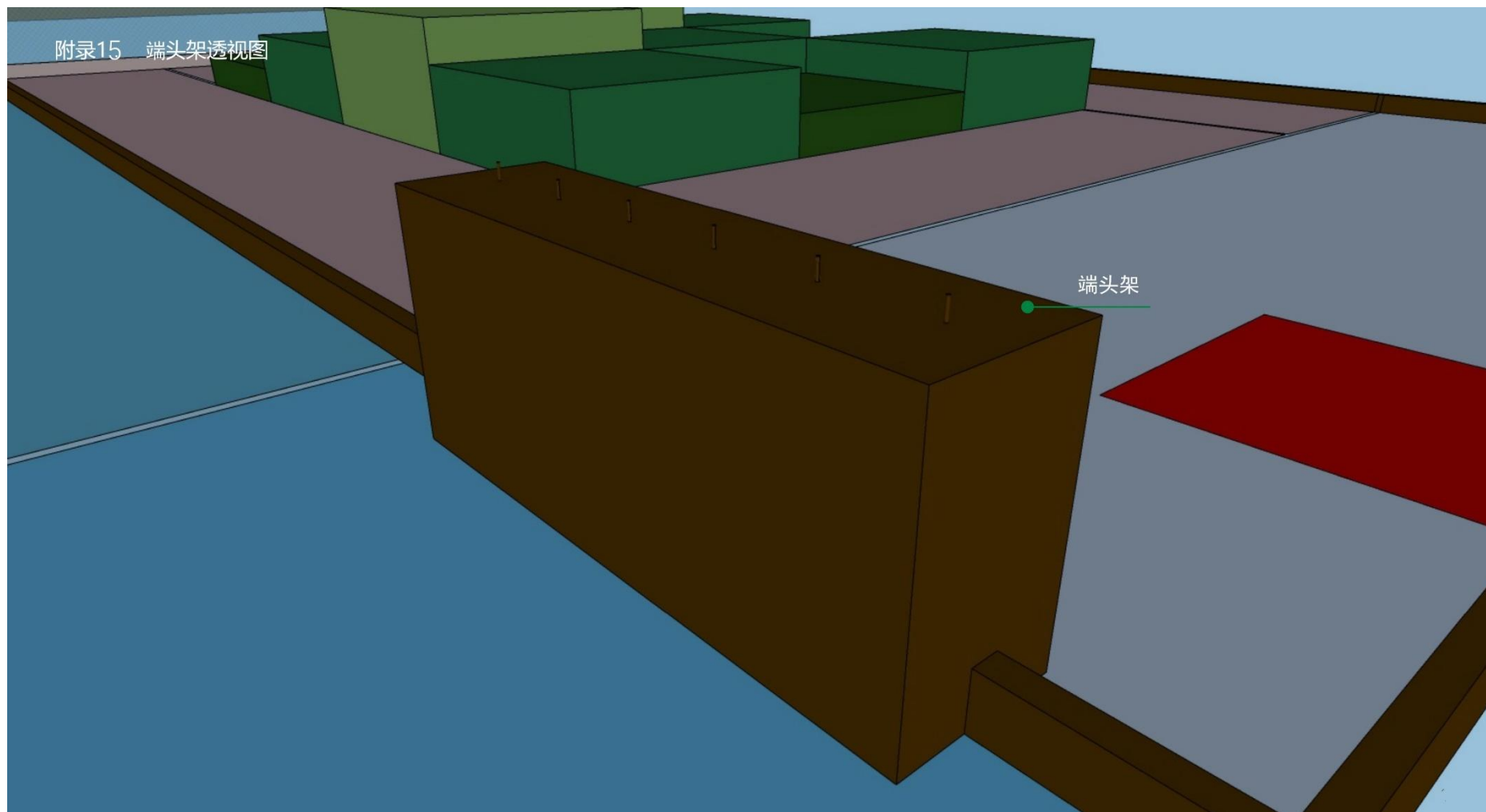

附录16 九宫格

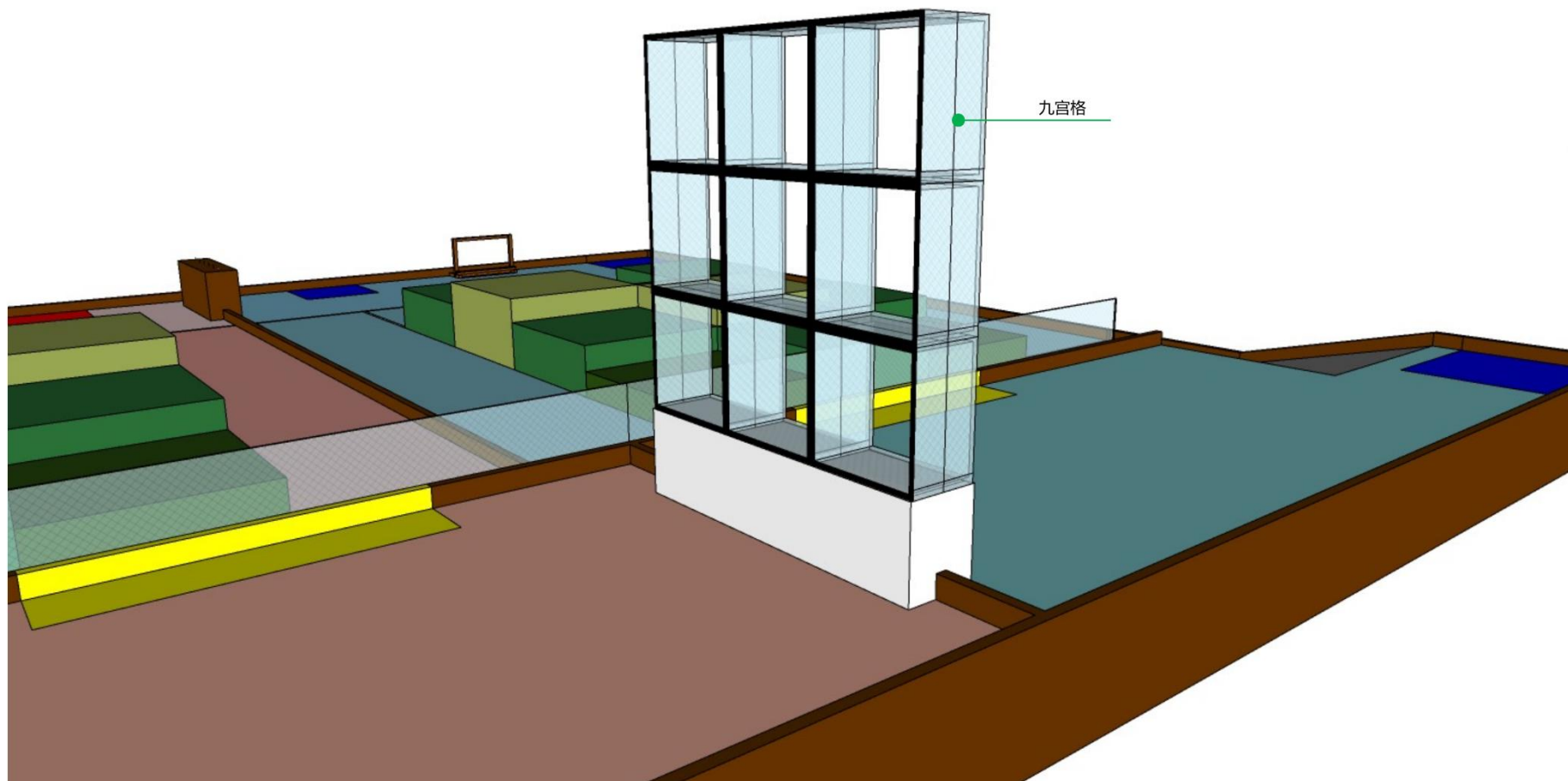

附录17 九宫格

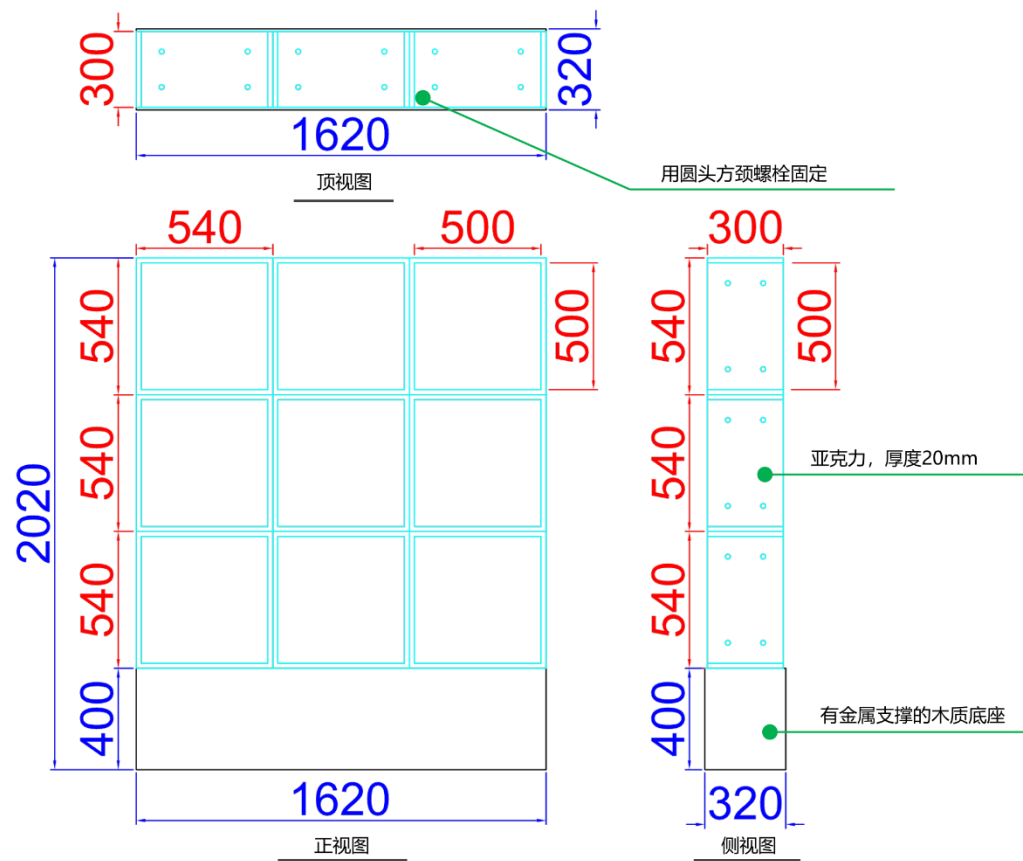
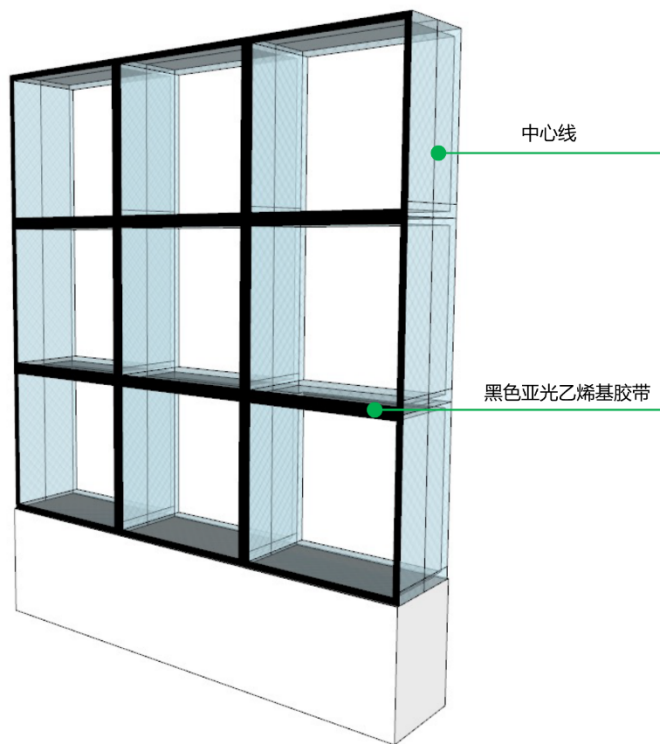

附录18 武术秘籍的纸板箱

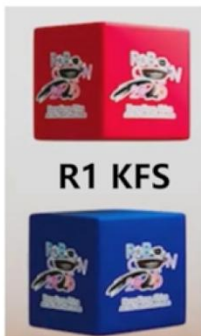

R1 KFS

尺寸：350 mm×350mm×350mm (5%)

材质：三层纸箱，外六面贴背胶纸

重量：630g (±20%)

外表面文字/图案：除底面外，其它5个外表面均为本届比赛Logo



R2 KFS

尺寸：350 mm×350mm×350mm (5%)

材质：三层纸箱，外六面贴背胶纸

重量：630g (±20%)

外表面文字/图案：除底面外，其它5个外表面均为相同的甲骨文文字



假 KFS

尺寸：350 mm×350mm×350mm (5%)

材质：三层纸箱，外六面贴背胶纸

重量：630g (±20%)

外表面文字/图案：除底面外，其它5个外表面为不相同的小篆体文字

附录19 武术秘籍识别图案

红队



R1 KFS

蓝队



R1 KFS

R2 KFS 红

假 KFS 蓝