



Parameter	Symbol	Rating	Units
Load Voltage	$V_L$	60	V
Load Current	$I_L$	0.40	A
On-Resistance	$R_{on}$	1	$\Omega$
I/O Breakdown Voltage	$V_{I/O}$	5000	Vrms



SMD-8

DIP-8

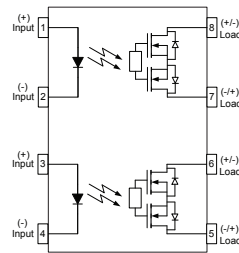

1,3. LED Anode  
2,4. LED Cathode  
5,6. Drain (MOS FET)  
7,8. Drain (MOS FET)

(1) 2 input

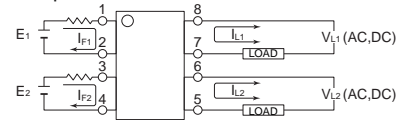

(2) 1 input

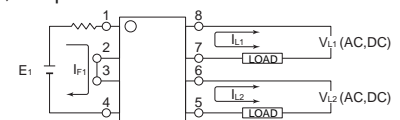

## SUPSiC PhotoRelays

- Long life (No limit on mechanical and electrical lifetime)
- Bounce-free switching
- Higher speed and high frequency switching
- Higher sensitivity (less power consumption)
- Immunity to EMI or RFI
- No have voltaic arc, bounce, and noise
- More resistant to vibration and impact
- AC or DC load switching
- Small package size

## Applications

- Telecom/Datacom switching
- Multiplexers
- Meter reading systems
- Data acquisition
- Medical equipment
- Battery monitoring
- I/O Sub-Systems
- Robotics
- Aerospace
- Home/Safety security systems
- Process Control
- Energy Management
- Reed Relay EMR Replacement
- Programmable Controllers

## TPYES

Category	Output Rating		Package	Part No.	Packing Quantity
	Load Voltage	Load Current			
AC/DC	60V	0.40A	DIP-8	GAQW412E	50pcs /tube
			SMD-8	GAQW412EH	1000pcs /reel

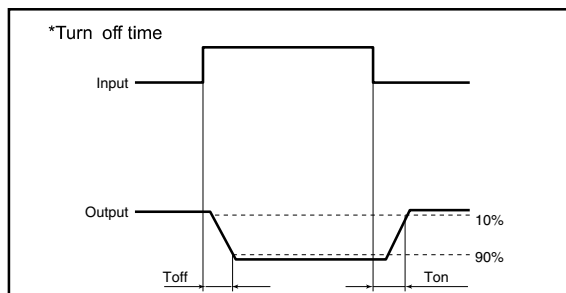

### Absolute Maximum Ratings (Ta = 25°C)

Item		Symbol	Value	Units	Note
Input	Continuous LED Current	$I_F$	50	mA	
	Peak LED Current	$I_{FP}$	1000	mA	f=100Hz, duty=1%
	LED Reverse Voltage	$V_R$	5	V	
	Input Power Dissipation	$P_{In}$	75	mW	
Output	Load Voltage	$V_L$	60	V(AC peak or DC)	
	Load Current	$I_L$	0.40	A	
	Peak Load Current	$I_{Peak}$	0.60	A	1ms(1 pulse)
	Output Power Dissipation	$P_{out}$	300	mW	
Total Power Dissipation		$P_T$	350	mW	
I/O Breakdown Voltage		$V_{I/O}$	5000	Vrms	RH=60%, 1min
Operating Temperature		$T_{opr}$	-40 to 85	°C	
Storage Temperature		$T_{sig}$	-40 to 100	°C	
Pin Soldering Temperature		$T_{sol}$	260	°C	10 sec max.

### Electrical Characteristics (Ta = 25°C)

Item		Symbol	MIN.	TYP.	MAX.	Units	Conditions
Input	LED Forward Voltage	$V_F$		1.2	1.5	V	$I_F=10mA$
	Operation LED Current	$I_{Fon}$		0.5	3.0	mA	
	Recovery LED Current	$I_{Foff}$	0.1	0.4		mA	
	Recovery LED Voltage	$V_{Foff}$	0.5			V	
Output	On-Resistance	$R_{on}$		1	3	$\Omega$	$I_F=5mA, I_L=Max$ Time to flow is within 1 sec.
	Off-State Leakage Current	$I_{Leak}$		0.1		$\mu A$	$V_L=Rating$
	Output Capacitance	$C_{out}$		165		pF	$V_L=0, f=1MHz$
Transmis sion	Turn-On Time	$T_{on}$		0.50	1.5	ms	$I_F=5mA, I_L=Max$
	Turn-Off Time	$T_{off}$		0.25	2.0	ms	
Coupled	I/O Isolation Resistance	$R_{I/O}$	$10^{10}$			$\Omega$	DC500V
	I/O Capacitance	$C_{I/O}$		0.8		pF	f=1MHz

Please obey the following conditions to ensure proper device operation and resetting. Input LED current (Recommended value):  $I_F \geq 5mA$  and  $\leq 30mA$

## Engineering Data

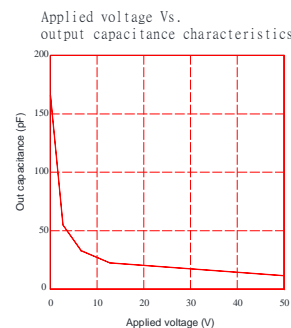
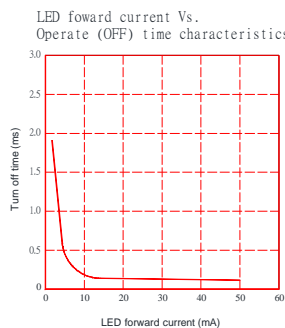
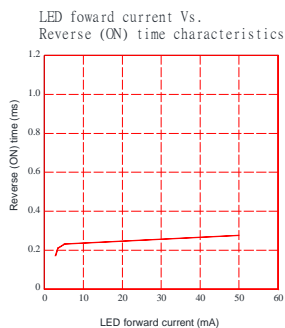
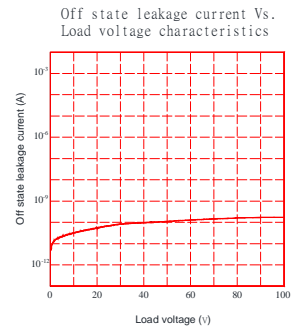
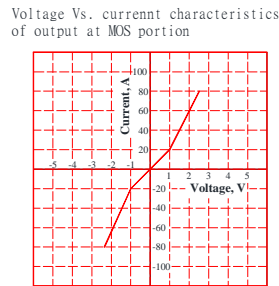
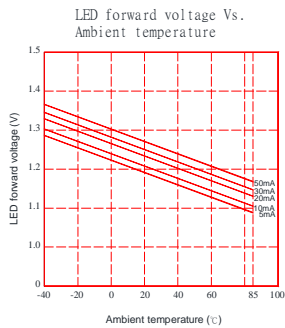
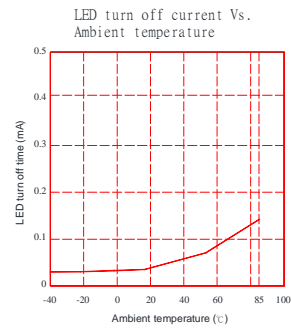
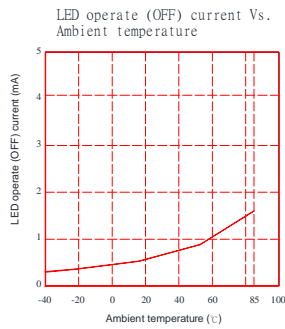
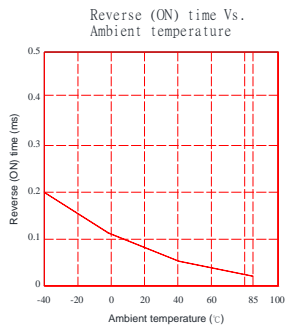
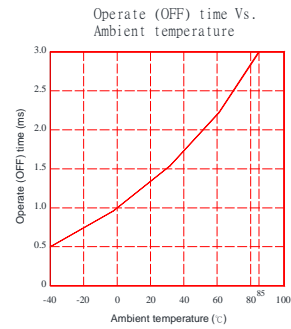
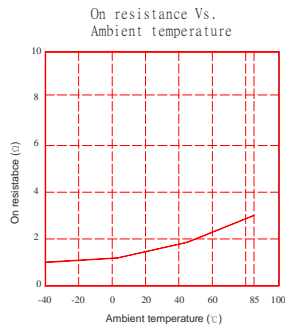
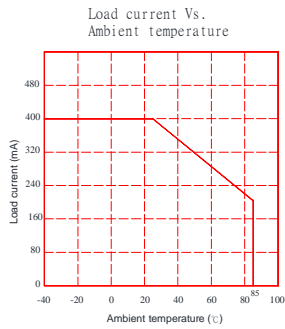

## Dimensions and DIP-8 Package Unit: mm

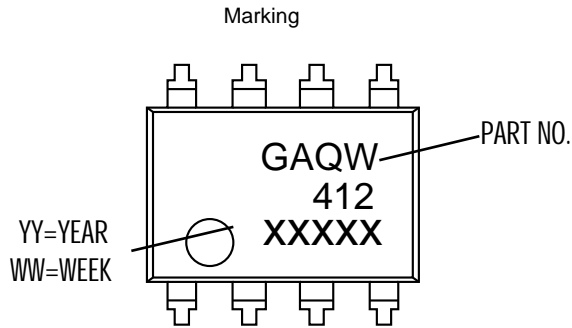

### Through hole terminal type

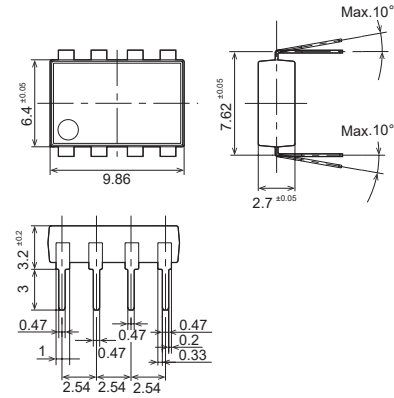

### PC board pattern (Bottom view)

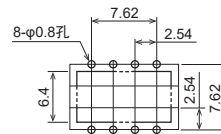

## DIP Tape dimensions Unit: mm

Devices are packaged in a tube so that pin No. 1 is on the stopper B side. Observe correct orientation when mounting them on PC boards.

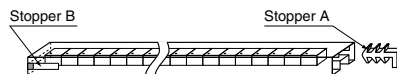

**Dimensions and SMD-8 Package** Unit: mm

Marking

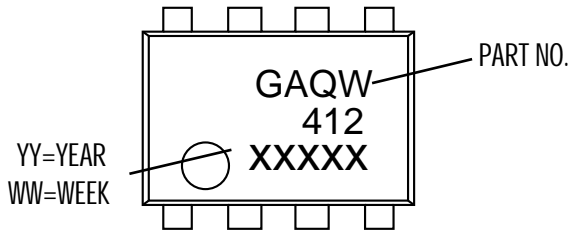

Surface mount terminal type

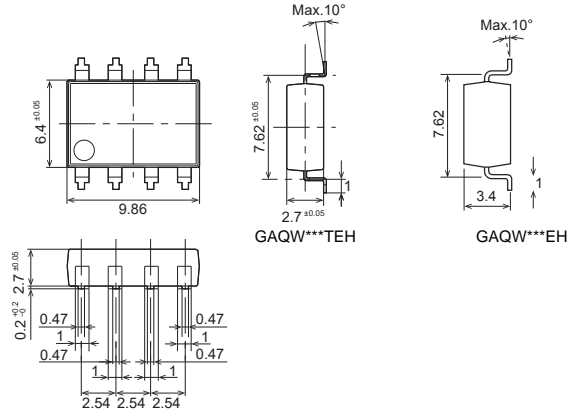

Recommended mounting pad  
(Top view)

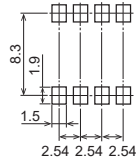

**Tape dimensions ( tape reel )**

Tape dimensions (Unit: mm)

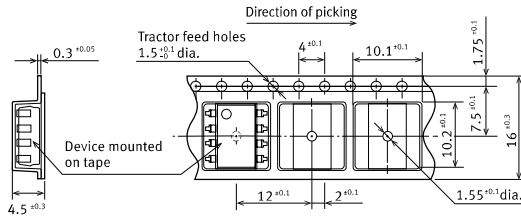

Dimensions of paper tape reel (Unit: mm)

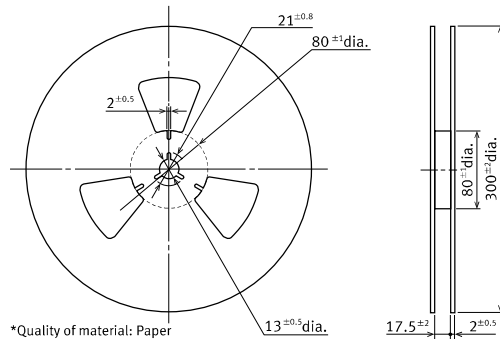

## Using Methods

Examples of resistance value to control LED forward current ( $I_F=5\text{mA}$ )

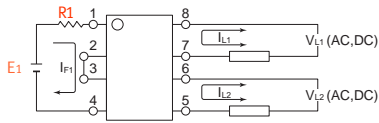

E1	R1 (Approx)
3.3V	300 $\Omega$
5.0V	600 $\Omega$
12V	1.9K $\Omega$
24V	4.1K $\Omega$

LED forward current must be more than 5mA , at I(MIN) , and less than 30mA , at I(MAX).

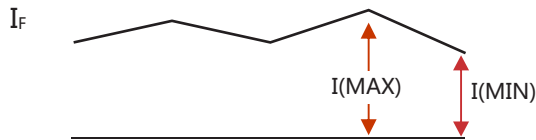

## Recommended Operating Conditions

Please obey the following conditions to ensure proper device operation and resetting. Input LED current (Recommended value):

Characteristic	Symbol	Min	Typ.	Max	Unit
Forward current	$I_F$	5.0	7.0	30	mA

## Protection Circuit

Output spike voltages:if an inductive load generates spike voltages which exceed heabsolute maximum rating, the spike voltage shall be limited.

Clamp diode is connected in parallel with the load.  
Absorb capacity with external diode.

CR Snubber is connected in parallel with the load.  
Absorb capacity with buffer capacity.

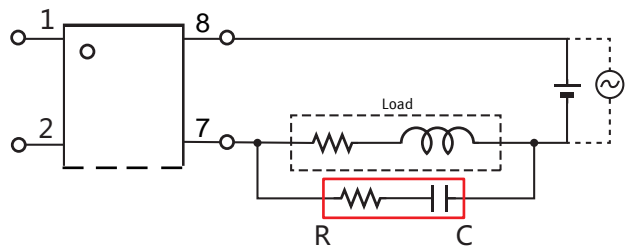
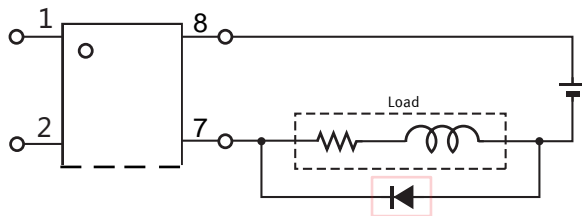

When adding diodes, buffer circuits (C-R), and other protections, they need to be installed near the MOS RELAY to be effective.  
Adding protection elements may result in a slow reset time, so adjust them according to the actual situation before use.

Note: When developing designs using this product, perform the expected performance of the equipment under the operating conditions recommended by the guidelines in this document. Continuous use under heavy loads (including, but not limited to, the application of high temperatures/current/voltage and significant changes in temperature, etc.) may result in deterioration of the reliability of this product.