

T31 手持地面站

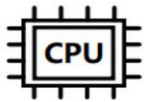

深圳市华之翼科技有限公司

WWW.CHINOWING.COM



Intel i7 6500U

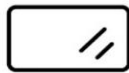

10 寸 1000 亮度



35 个编辑通道

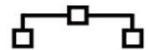

一机两控



5-150KM



中继\组网



一控多机



4 小时续航

产品介绍

T31 手持地面站是一款高度集成、功能丰富的单兵控制设备，专为无人车、机器人控制以及遥控无人机、无人船等应用而设计。它提供实时数据反馈和遥控功能，支持航线规划，并在 Windows 或 Linux 系统平台上运行主流地面站软件。配备工业级电脑和军工级传输链路，保证操作简单且便于携带，适用于军事、工业、航空航天和应急救援等多个领域，是一款多功能、高性能的控制设备。

面板介绍

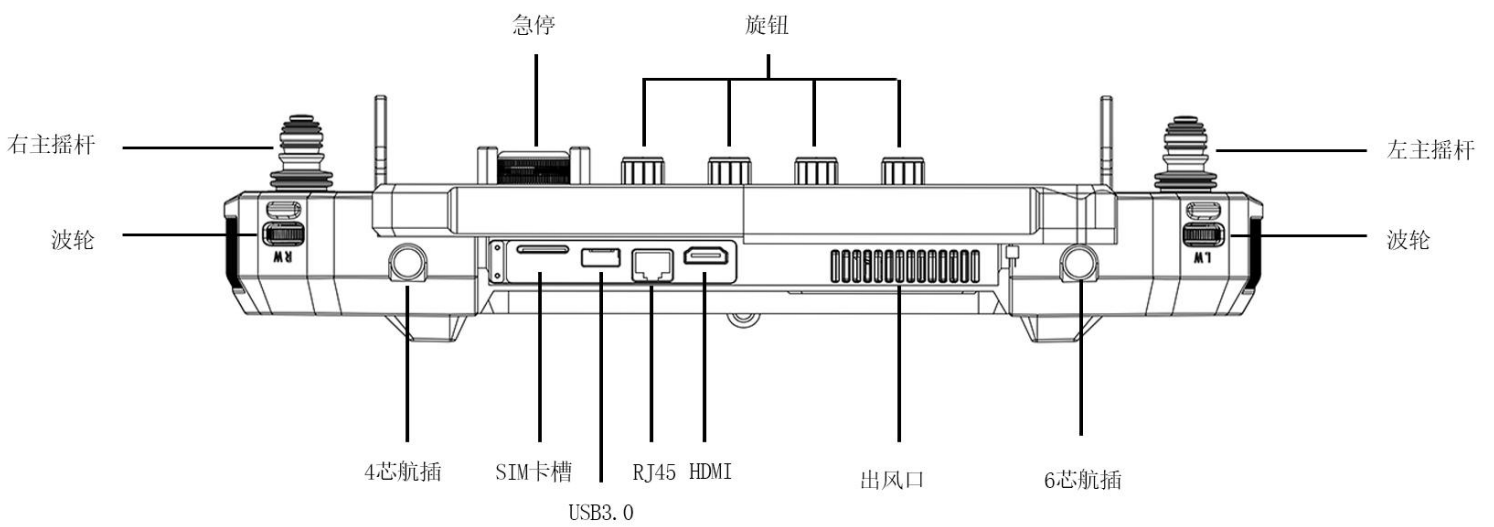
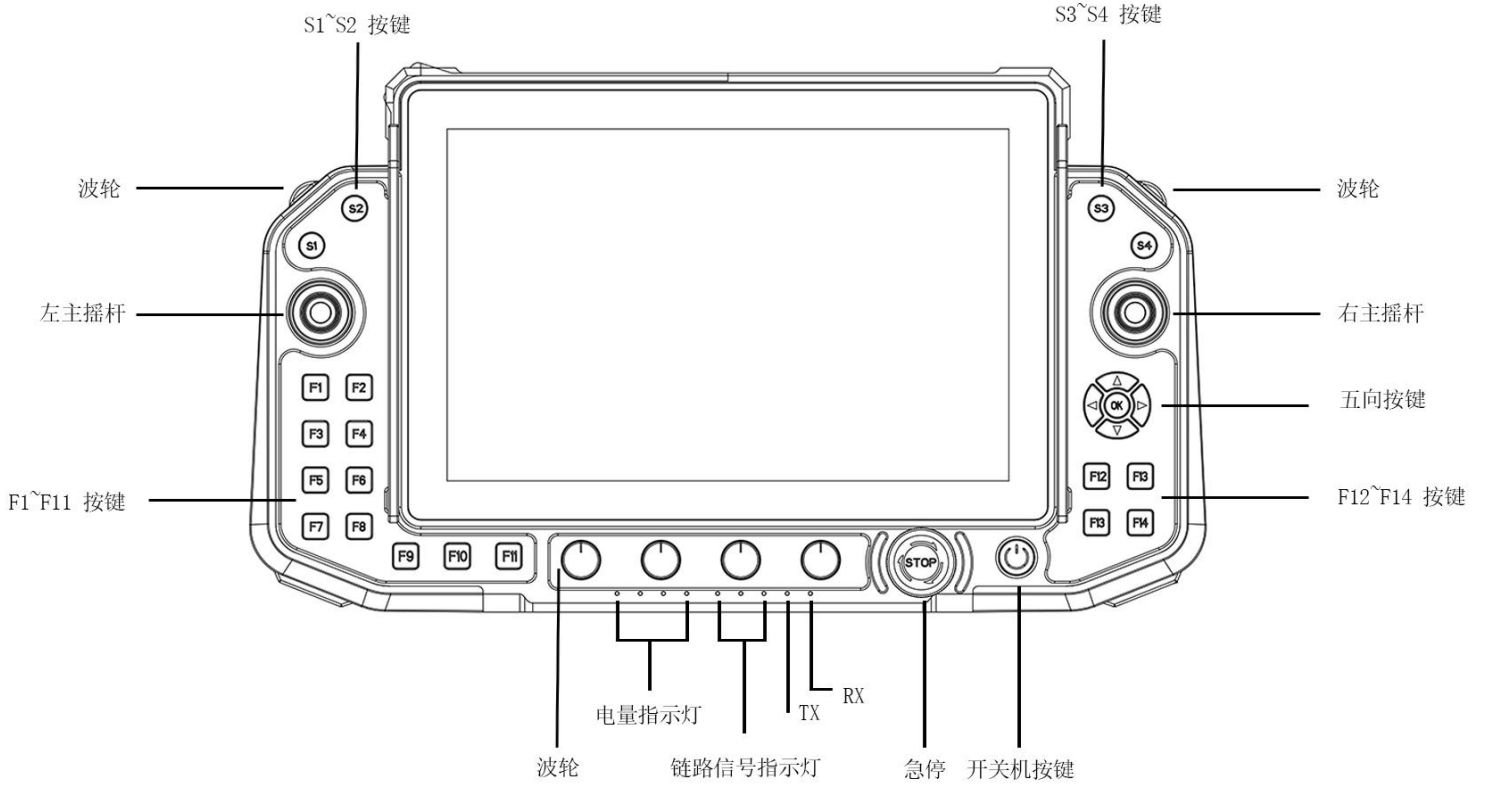

参数介绍

■ 产品规格	
整体尺寸	378mm(L) × 221mm(W) × 54mm(H)
整机重量	2750g (不含棒状天线 80g) 无链路 2540g
显示屏	10.1 英寸 1280*800, 1000 亮度 (选配 1920*1200 800 亮度)
接口	USB3.0、4GSIM、LAN、VGA、HDMI、
充电口	Type-c 100w
防护等级	IP53
工作温度	-20~60℃
■ 电脑周边	
CPU	Intel i5 6200U/2.3HZ (选配 Intel i7 6500U/2.3HZ)
操作系统	Windows10 \ Linux \ 麒麟
内存+硬盘	16G+512G (选配 32+1T)
网络	WIFI, 蓝牙, 4G
■ 遥控系统	
物理通道	主通道*4、按键*24、旋钮*4、波轮*2、急停*1
遥控功能	双 SBUS 独立输出, 可同时控无人机及其 载荷
单线总线端口	USB in×1 SBUS out×2
遥控延迟	40ms
■ 电池相关	
电池容量	10500mAh/12.6V
工作时间	满电 4 小时续航 (支持外挂电源)
■ 天空端 (V21)	
整机重量	天空 100g (不含天线 66g)
整机尺寸	85mm*55mm*30mm
工作频段	800MHz / 1.4GHZ / 2.4GHZ
透传串口	TTL / RS232
工作带宽	1.4-20M (可调)
视频延迟	300ms
工作温度	-20~+65℃
工作电压	7.4-50V 2~6S 电池

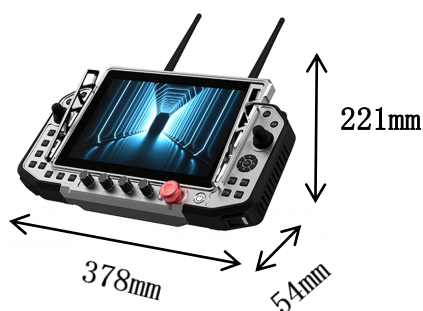

可选搭配图数一体链路介绍

点对点点对多



15KM (集成)



20/30KM



5/50/80/150KM

MESH 组网



10KM



15KM



50KM

4K 图传



20KM



MESH 20KM

定向跟踪云台



80/150KM

15Km 以上可
选配支架



连接方式

方式一：集成链路连接

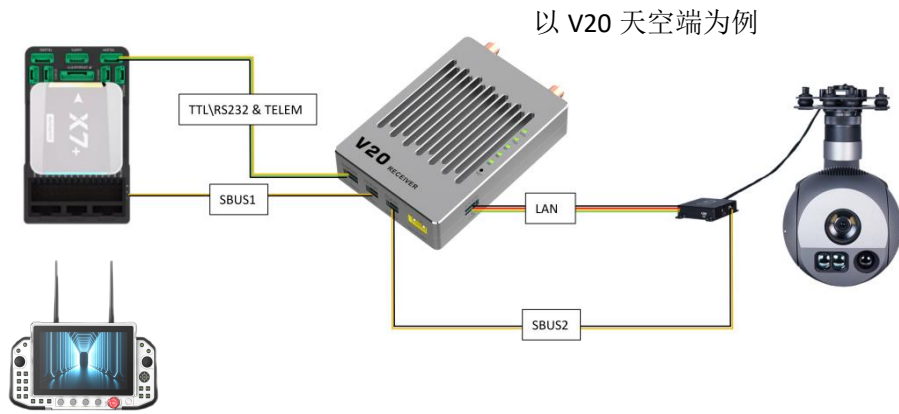

方式二：集成链路多吊舱连接

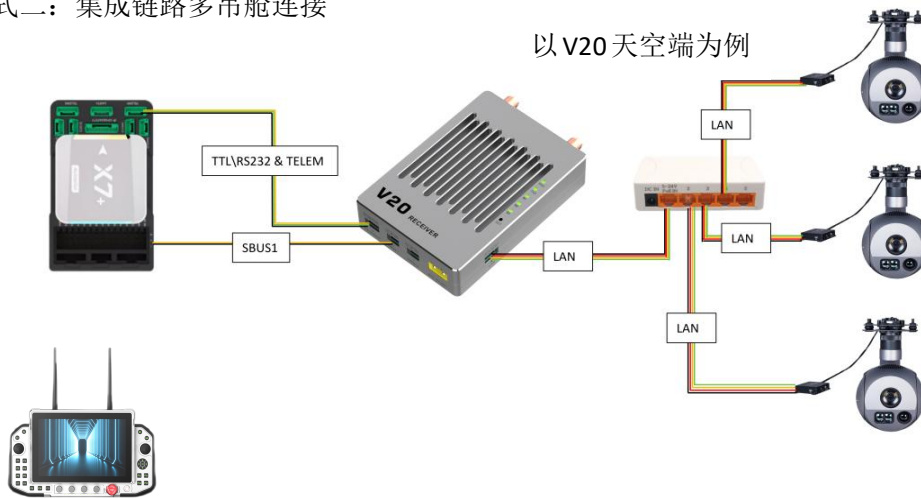

方式三：远距离或第三方链路连



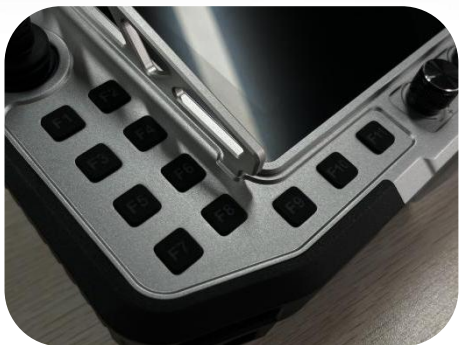

自由编辑通道



急停按键



35 个通道



集成链路



外扩第三方链



外部接口 T31N