



2-pedal medical foot switch MKF 2-MED GP211 Material no.: on request

Product features

- Robust fibreglass-reinforced plastic foot control
- Plastic housing for high stability and low weight
- Waterproof: IPX8 (IEC 60529)
- Wireless signal transmission via steute wireless SW2.4LE-MED (optional)
- Additional push buttons for extra functionality (optional)
- Collapsible stainless steel carrying handle (optional)

Notes

- Photo shows optional accessories

Dimensions

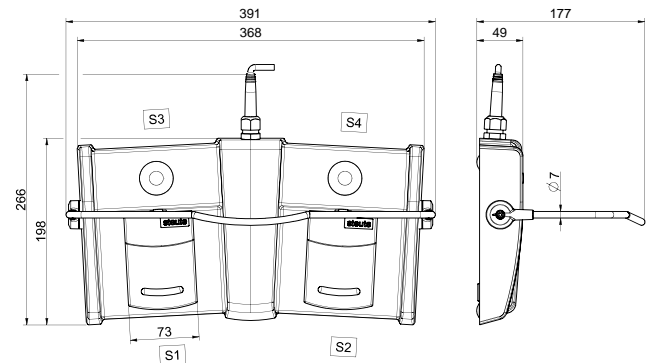

Technical data

Applied standards

IEC 60601-1, ANSI/AAMI ES60601-1, IEC 60529

Pedal

thermoplastic, shockproof, self-extinguishing UL 94 V-0/V-2

Housing

thermoplastic, shockproof, self-extinguishing UL 94 V-0,
Pantone Cool Gray 1C

Degree of protection

IPX8 (IEC/EN 60529)

Switching elements

reed contact / micro switch / Hall sensor

Switching system

1 – 2 NO contacts / 1 change-over / analogue output 0 ... 10
VDC, 0 ... 20 mA, 4 ... 20 mA

Mechanical life

> 1 million operations

Connection

2 m cable, other lengths optionally available

Switching voltage

max. 25 VAC / 60 VDC

Switch-on current

max. 1 A

Switching capacity

Reed contacts: max. 20 VA, micro switch: max. 30 VA

Supply voltage Hall sensor

15 ... 30 VDC / max. 25 mA